

Drain: MATHEAD DRAIN Drain #: 203  
Improvement/Arm: MATHEAD - SECTION 12  
Operator: JOH Date: 1-27-04  
Drain Classification: Urban/Rural Year Installed: 1985

### GIS Drain Input Checklist

- Pull Source Documents for Scanning JOH 1-27
- Digitize & Attribute Tile Drains N/A
- Digitize & Attribute Storm Drains JOH 1-27
- Digitize & Attribute SSD JOH 1-27
- Digitize & Attribute Open Ditch N/A
- Stamp Plans JOH 1-27
- Sum drain lengths & Validate JOH 1-27
- Enter Improvements into Posse JOH 1-27
- Enter Drain Age into Posse JOH 3-2
- Sum drain length for Watershed in Posse JOH 3-2
- Check Database entries for errors JOH 1-27

**Gasb 34 Footages for Historical Cost  
Drain Length Log**

Drain-Improvement: MASTHEAD DRAIN - MASTHEAD - SECTION 12

Drain Type:	Size:	Length <small>SURVEY AS RACED</small>	Length (DB Query)	Length Reconcile	If Applicable	
					Price:	Cost:
SSO	6"	1,070'	1,070'	∅	2.00	2,140.00
RCP	12"	1,174'	1,86'	-988	7.25	1,348.50
	15"	724'	102'	-622	9.50	969.00
	24"	204'	204'	∅	18.00	3,672.00
	30"	177'	167'	-10'	24.60	4108.20
	33"	249'	219'	-30'	28.50	6,241.50
CMP	12"	26'	1,098'	+1,072	14.00	15,372.00
	15"	∅	622'	+622	18.00	11,196.00
	24"	45'	45'	∅	50.00	2,250.00
	33"	∅	20'	+20	67.00	1,340.00
SWALE/OPEN DITCH		1,650'	1,650'	∅	19.55	32,257.50

Sum:            5,319'      5,383'      +64'                    \$80,894.70

Final Report: \_\_\_\_\_

Comments: \_\_\_\_\_  
 \_\_\_\_\_  
 \_\_\_\_\_  
 \_\_\_\_\_  
 \_\_\_\_\_  
 \_\_\_\_\_



SURVEYOR'S OFFICE

# Hamilton County

Kenton C. Ward, Surveyor

776-9626

Noblesville, Ind. 46060 December 26 1984

TO: Hamilton County Drainage Board

RE: Masthead Drain, Section 12

Attached is a petition, non-enforcement request, plans, calculations, quantity summary and assessment roll for the Masthead Drain, Section 12. I have reviewed the submittals and petition and have found each to be in proper form.

I have made a personal inspection of the land described in the petition. Upon doing so I believe that the drain is practicable; will improve the public health, benefit a public highway and be of public utility and that the costs, damages and expenses of the proposed drain will probably be less than the benefits accruing to the owners of land likely to be benefitted.

The drain will consist of the following:

12" RCP	1174 L.F.	12" CMP	26'
15" RCP	724 L.F.	24" CMP	45'
30" RCP	177 L.F.	24" RCP	204'
33" RCF	249 L.F.		
6" SSD	1070 L.F.		
Swales/open ditch	1650 L.F.		

The total length of the drain will be 5319 feet.

I recommend a maintenance assessment of \$20.00 per lot or block with \$2.00 per acre for roadways with this assessment the total annual assessment for this section will be \$1060.00

At this time the system is complete except for the SSD. A certified check

has been submitted to cover the cost of completion. This check will be

returned to Shorewood upon completion of the section.

I recommend a hearing be set for the February 1985 meeting.

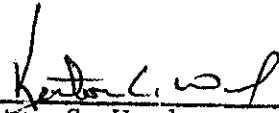

Kenton C. Ward  
Hamilton County Surveyor

KCW/no

*Filed*  
*Hamilton County Drainage Board*  
*Maryellen Oldham - Secretary*

STATE OF INDIANA }  
COUNTY OF HAMILTON } SS:

To: Hamilton County Drainage Board, Noblesville, Indiana  
c/o County Surveyor, Courthouse, Noblesville, Indiana

In the matter of Masthead Subdivision, Sections  
Twelve Drain Petition.

Petitioner is the owner of all lots in the land affected by the proposed new legal drain. The drainage will affect various lots in Masthead-Section Twelve, a subdivision in Hamilton County, Indiana. The general route of such drainage shall be in existing easements and along public roads as shown in the plans on file in the Surveyor's Office.

Petitioner believes that the cost, damages and expenses of the proposed improvement will be less than the benefits which will result to the owners of the land likely to be benefited thereby. Petitioner believes the proposed improvement will:

- (a) improve public health
- (b) benefit a public street
- (c) be of public utility

Petitioner agrees to pay the cost of construction of the storm sewers and requests periodic maintenance assessments by the Board thereafter. The Petitioner also agrees to the following:

1. To provide the Drainage Board a performance bond for the portion of the storm sewer system which will be made a legal drain. The bond will be in the amount of 100% of the Engineers estimate. Bond will be in effect until construction of 100% of the system is completed and so certified by the Engineer.
2. The Developer shall retain the Engineer throughout the construction phase. At completion of the project, the Developers Engineer shall certify that the storm sewer system which is to be maintained as a legal drain has been constructed as per construction plans.
3. Any changes made in the field shall be documented and given to the Surveyor to be placed the the Drain file.
4. The developer shall instruct his Engineer to provide a reproducible print on a 24" x 36" mylar of the final design of the Drainage System.

The Petitioner further requests that the Drain be classified as an Urban Drain.

*The Shropshire Corp*  
Owner  
*Eugene A. Smith, Senior Vice President*

BEFORE THE HAMILTON COUNTY

DRAINAGE BOARD IN THE

MATTER OF THE Masthead Drain, Section 10, 12, 13 Drain

NOTICE

TO WHOM IT MAY CONCERN AND

---

---

---

---

---

---

Notice is hereby given of the Hearing of the Hamilton County Drainage Board on the Masthead, Sec. 10, 12, 13 Drain, on February 11, 1985 at 9:05 A.M. in the Commissioner's Court, 3rd floor, in the Hamilton County Courthouse Noblesville, Indiana and which the Maintenance Report of the Surveyor and the Schedule of Assessments made by the Drainage Board have been filed and are available for public inspection in the office of the Hamilton County Surveyor.

HAMILTON COUNTY DRAINAGE BOARD

ATTEST:

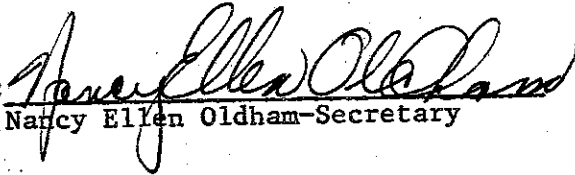
  
Nancy Ellen Oldham-Secretary

ONE TIME ONLY

BEFORE THE HAMILTON  
COUNTY DRAINAGE BOARD  
IN THE MATTER OF THE

Masthead, Sec. 10, 12, 13 DRAIN

NOTICE

Notice is hereby given pursuant to Section 405 of the 1965 Indiana Drainage Code that this Board, prior to final adjournment has issued an order adopting the Schedule of Assessments, filed the same and made public announcement thereof at the hearing and ordered publication. If judicial review of the findings and order of the Board is not requested pursuant to Article Eight of this Code within twenty (20) days from the date of this publication, the order shall become conclusive.

HAMILTON COUNTY DRAINAGE BOARD

ATTEST:

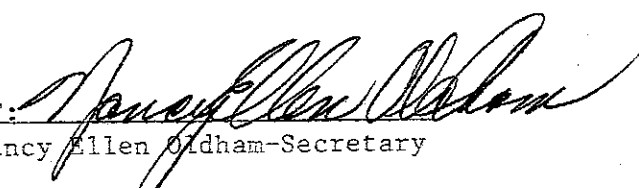
  
Nancy Ellen Oldham-Secretary

One Time Only

CERTIFICATE OF COMPLETION AND COMPLIANCE

TO: COUNTY SURVEYOR'S OFFICE, HAMILTON COUNTY  
ATTN: Mr. Kenton Ward  
FROM: Paul I. Cripe, Inc., Engineers  
SUBJECT: Masthead Subdivision - Section 12

I hereby certify that

- 1) I am familiar with the plans and specifications for the above referenced project,
- 2) I have personally observed the completion of the above referenced project, and
- 3) To the best of my knowledge, information and belief, the above referenced project has been performed and completed in conformity with all plans and specifications, except for revisions as noted on as-built plans.

Signature Joseph A. Sharp Date 8/23/85  
Type or Printed Name Joseph A. Sharp  
Business Address 7172 Graham Road  
Indianapolis, IN 46250  
Telephone 842-6777

Seal

Indiana Registration Number

15179



ADM:t1



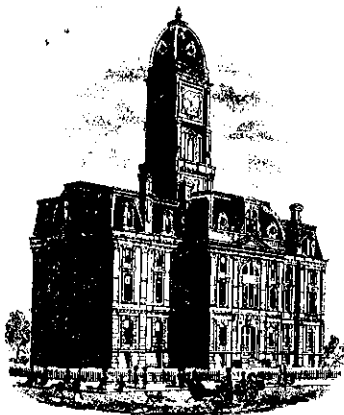

SURVEYOR'S OFFICE  
**Hamilton County**

*Kenton C. Ward, Surveyor*

776-9626

*Noblesville, Ind. 46060* December 31, 1985

TO: Hamilton County Drainage Board

RE: Masthead Drain, Section 12

Attached is an engineers Certificate of Completion and Compliance and a as built development plan, showing the regulated drainage facilities for Masthead Section 12. A final inspection on the drainage facilities was conducted in October 1985. At that time it was found, that the drainage system was complete and acceptable.

The Board should note a few modifications from the original set of plans and my report dated December 26, 1984. One of the changes is West of Structure 460. During construction, it was discovered that the 12" CMP shown as existing, in fact did not exist. Instead of extending a 12" RCP to pick up the structure, a 10' length of 12" RCP was stubbed out of Structure 460, to the West. This reduced the length by 16' of 12" CMP. The storm sewer along the East line of Lots 411 and 412 was reduced in length by ten (10) feet of 33" RCP.

Also, at the North East corner of Lot 411, 55' of 12" CMP was added. The total length for this section is now 5,348 feet.

The Board should also note that the only S.S.D included in the regulated drain system is that 6' S.S.D which serves Lots 408, 411, 398 to 400, 385, 386 and 403 to 406.

Also, attached is a nonenforcement request, which should be approved and signed by the Board.

*Kenton C. Ward*  
Kenton C. Ward  
Hamilton County Surveyor

# CONSTRUCTION PLANS

## FOR

# MASTHEAD SECTION 12

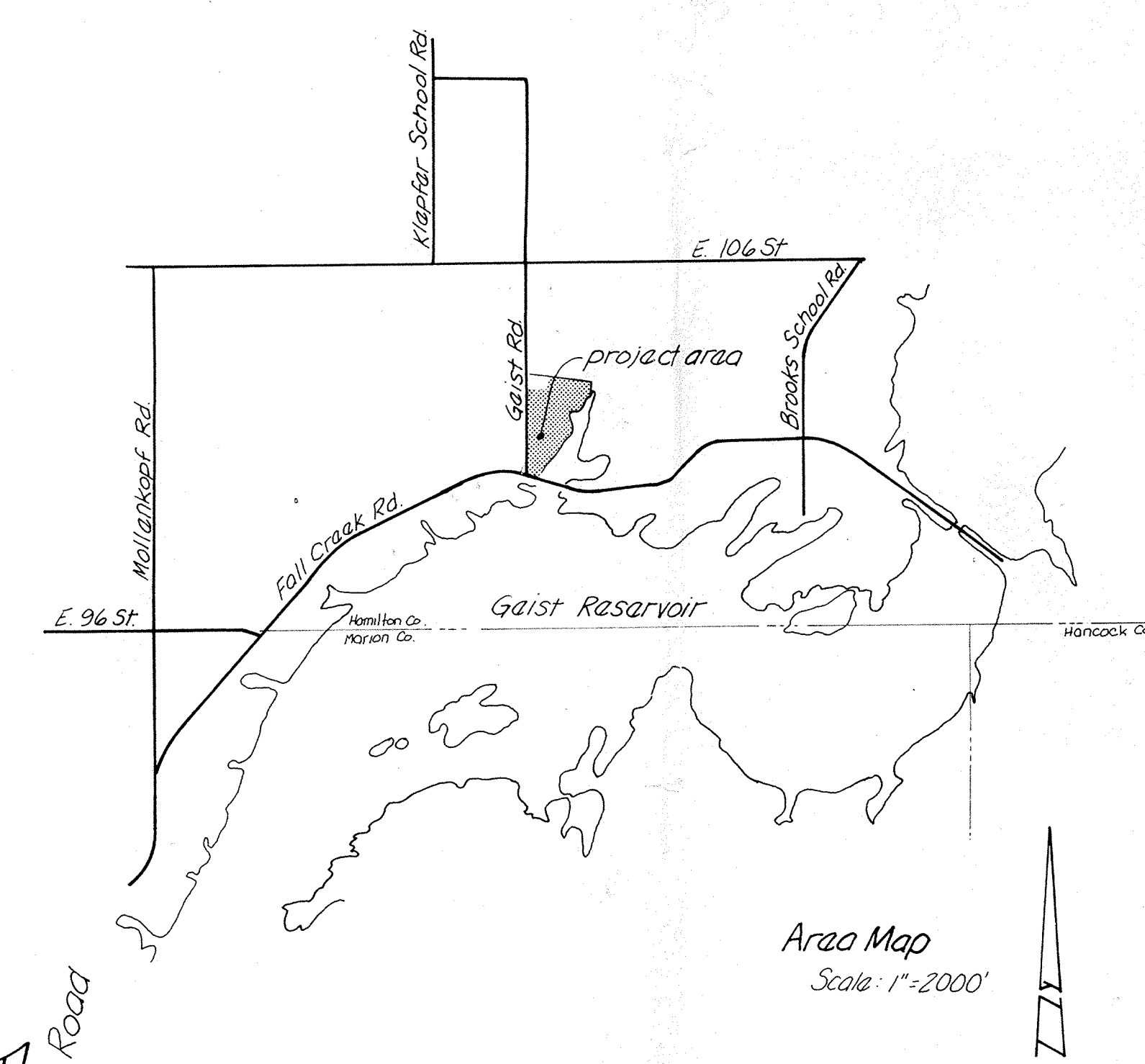
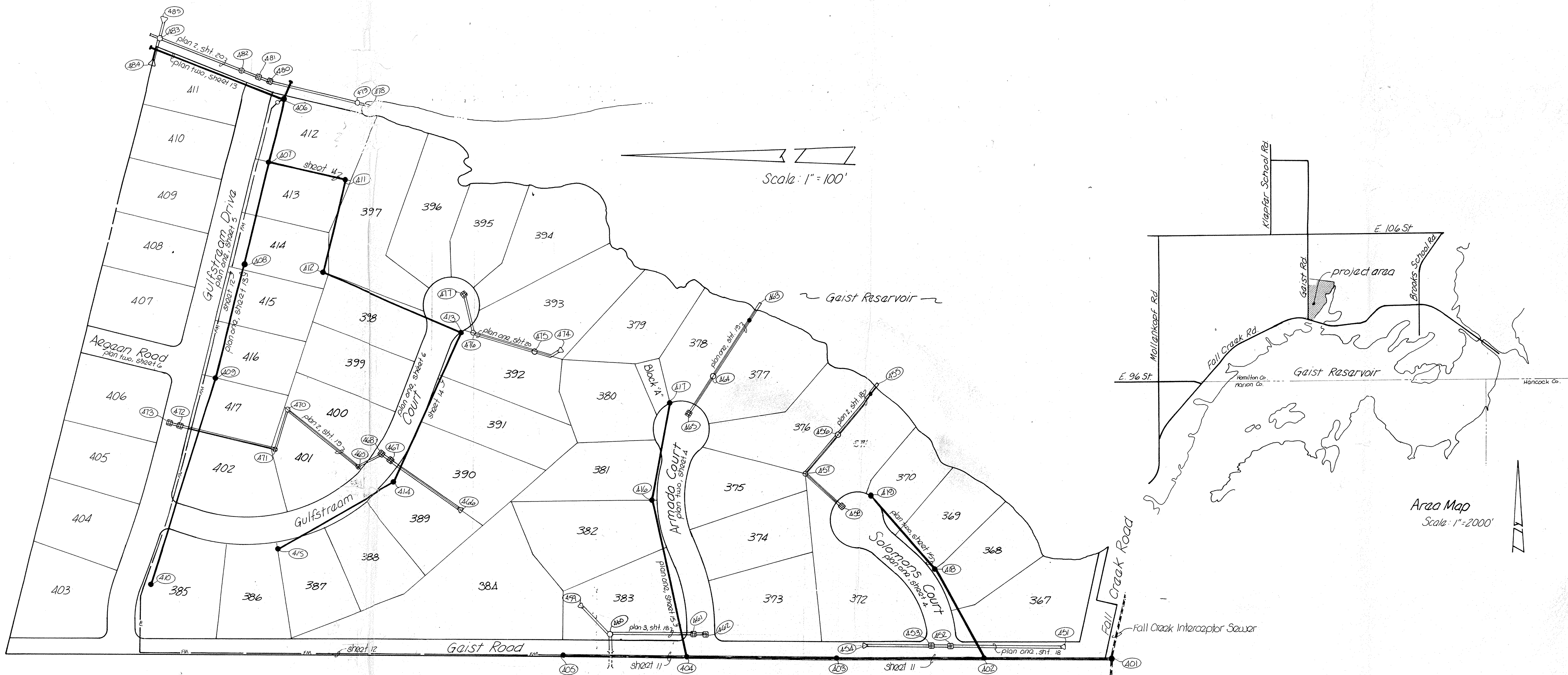

INDEX	
SHT	DESCRIPTION
1	cover sheet
2	site development plan - South 1/2
3	site development plan - North 1/2
4	streets - plan & profile
5	streets - plan & profile
6	streets - plan & profile
7	streets - details
8	streets - details
9	streets - details
10	streets - details
11	sanitary sewer - plan & profile
12	sanitary sewer - plan & profile
13	sanitary sewer - plan & profile
14	sanitary sewer - plan & profile
15	sanitary sewer - plan & profile
16	sanitary sewer - plan & profile
17	lift station details
18	storm sewer - plan & profile
19	storm sewer - plan & profile
20	storm sewer - plan & profile
21	standard details & specifications
22	standard details & specifications

BENCHMARKS	

REVISIONS	
7-12-84	NOTED EXISTING PIPES ALONG GEIST RD.
8-20-84	SHOW PROPOSED PUMP ALONG GEIST RD. REV STORM SEW.
10-12-84	REV PER NOBLESVILLE TAC
10-31-84	REV 550

CERTIFIED BY	REVISIONS	<b>PAUL I. CRIFE, INC.</b> 7172 GRAHAM ROAD INDIANAPOLIS, INDIANA 46250 317-842-6777	TECH. CHK.	DRAWN BY	SCALE	DATE	CLIENT	DWG. TYPE	FILE NUMBER	SHEET
			DFTNG. CHK.	BTW	noted	6-27-84	Masthead Sec. 12			
DATE				DRAWING TITLE	Cover Sheet			JOB NUMBER		1
								84100	00012	OF 22



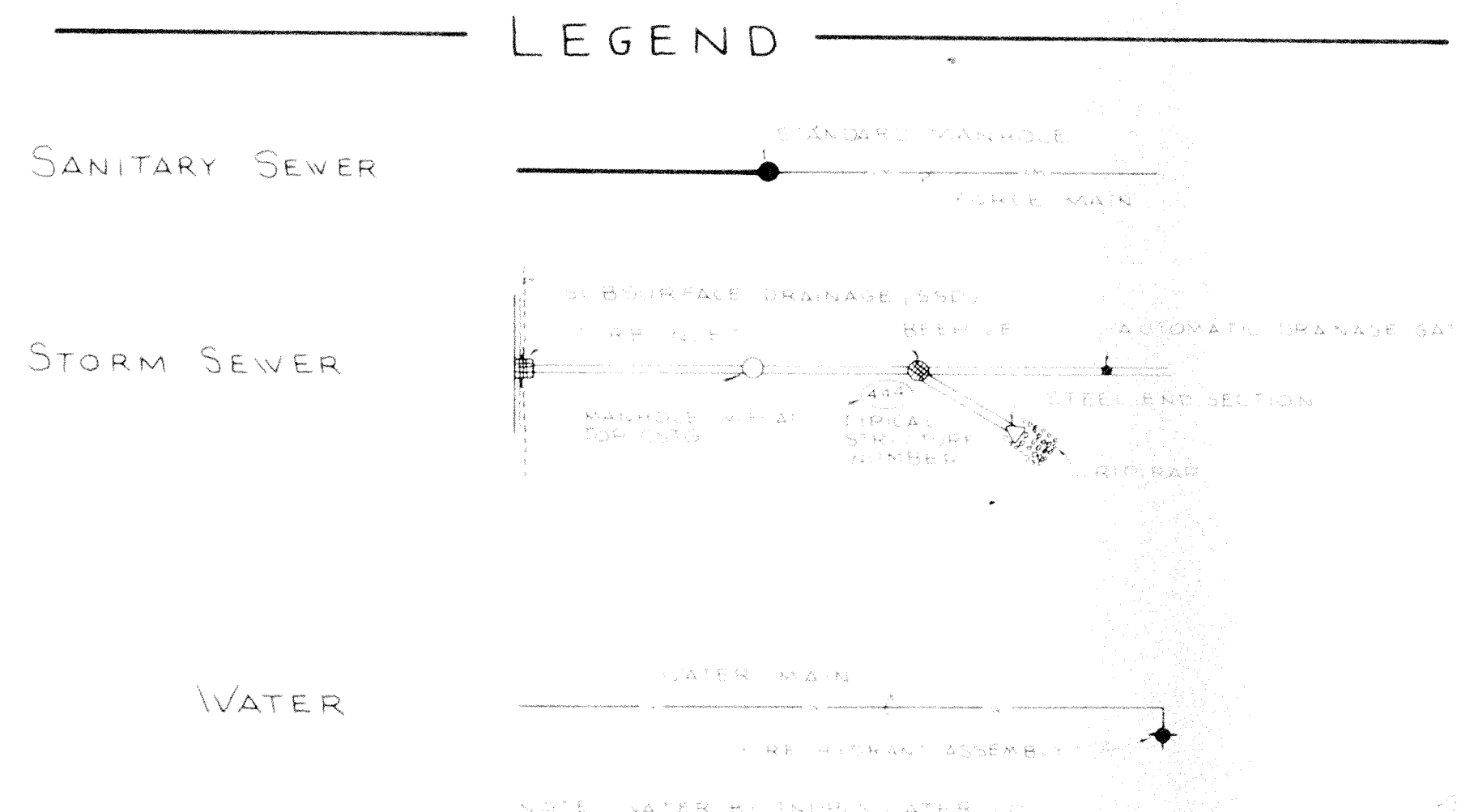

TON COUNTY INDIANA 1823

This information was gathered for input into the Hamilton County Geographical Information System. This document is considered an official record of the GIS.

Entry Date: 1-23-04

Entered by: JPH

CERTIFIED BY	REVISIONS	<b>PAUL I. CRIFE, INC.</b> • CIVIL ENGINEERING 7172 GRAHAM ROAD • LAND SURVEYING INDIANAPOLIS, INDIANA 46250 • ARCHITECTURE (317) 842-6777 • LAND PLANNING	TECH. CHK	DRAWN BY	SCALE	DATE	CLIENT	DWG. TYPE	FILE NUMBER	SHEET
DATE			DFTNG. CHK	JG	1"=50'	6-27-84	MASTHEAD - SEC. 12			3
			DRAWING TITLE				JOB NUMBER		OF 22	
			SITE DEVELOPMENT PLAN - NORTH HALF				84100-00012			



LEGEND

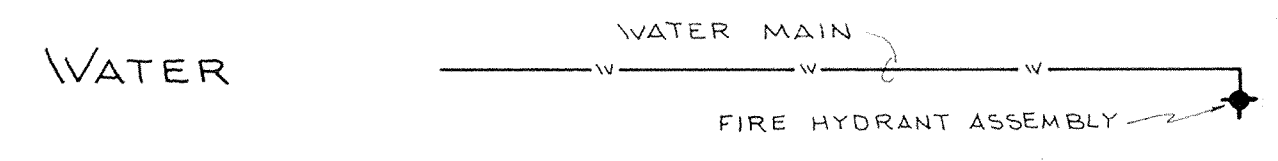
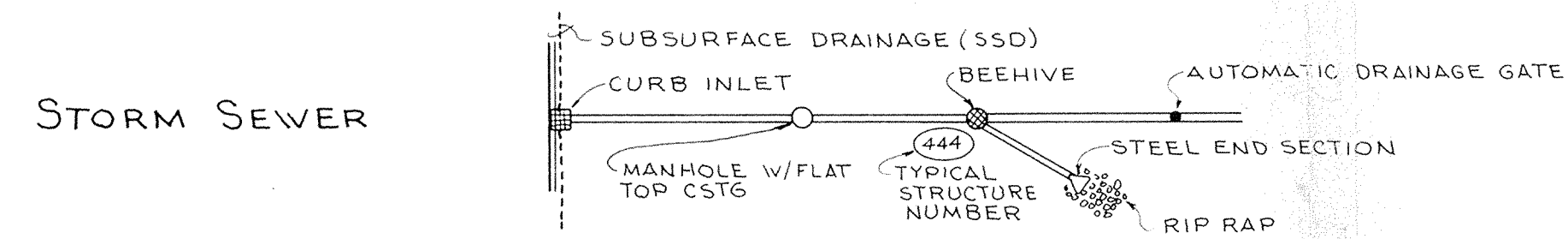
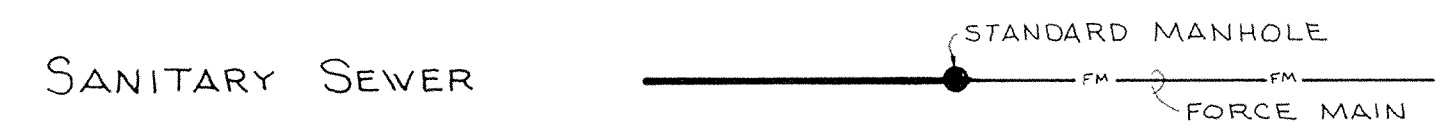

NOTE: WATER BY INOPLS WATER CO.

This information was gathered for input into the Madison County Geographical Information System. This information is considered an official record of the GIS.

Entry Date: 1-23-04

Entered by: JOH

NOTE: BEARINGS, DIMENSIONS & EASEMENTS ARE SHOWN FOR REFERENCE ONLY & DO NOT NECESSARILY DEPICT ACTUAL RECORDED INFORMATION. SEE RECORDED PLAT FOR EXACT INFORMATION.

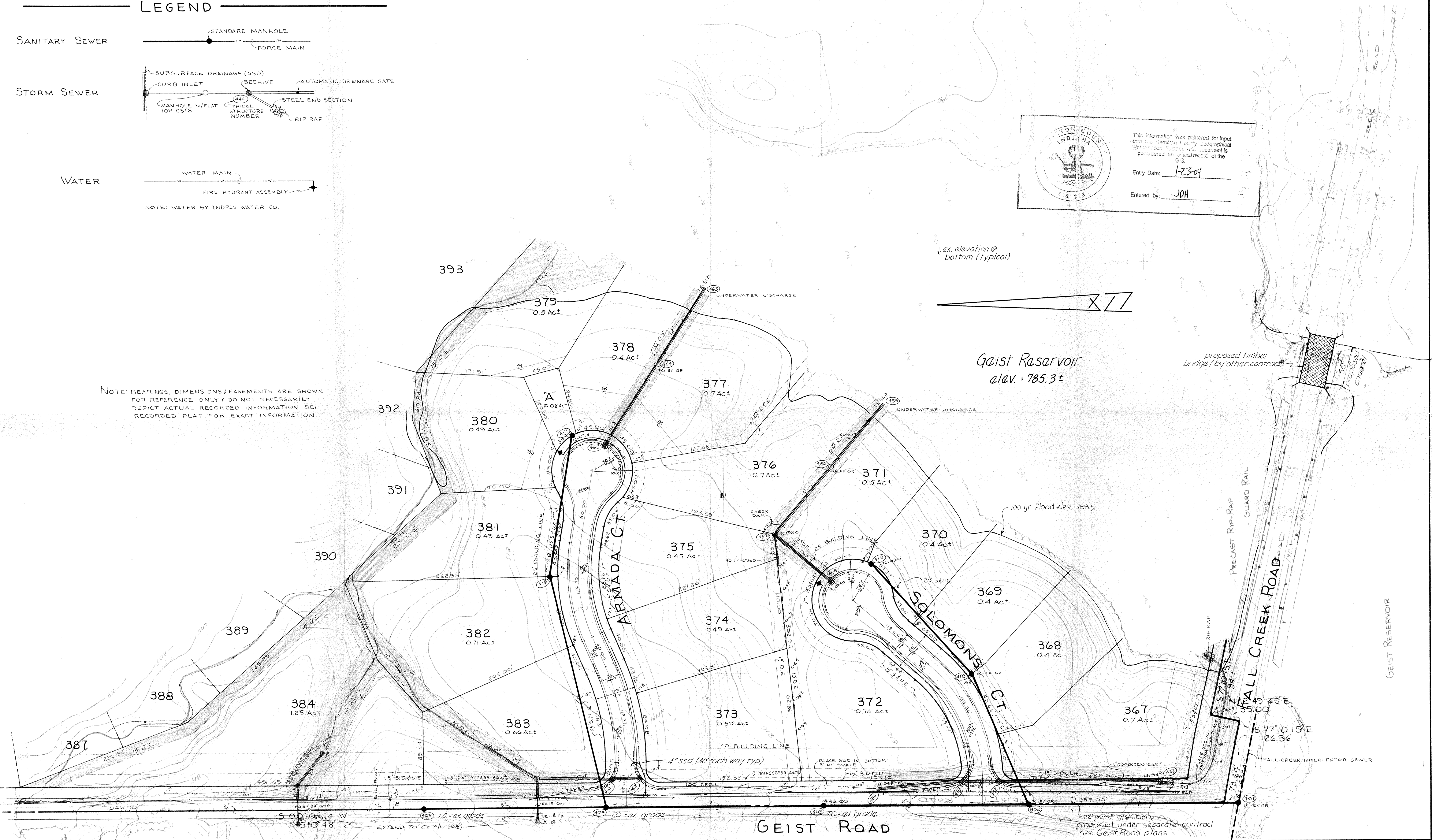

CERTIFIED BY	DATE
--------------	------

REVISIONS
8-17-84 rev storm-lots 383/384 added esmts.
10-12-84 REV PER TAC
10-31-84 REV SSD

**PAUL I. CRIFE, INC.** • CIVIL ENGINEERING • LAND SURVEYING • ARCHITECTURE • LAND PLANNING

7172 GRAHAM ROAD  
 INDIANAPOLIS, INDIANA 46250  
 (317) 842-6777

TECH. CHK.	DRAWN BY	SCALE	DATE	CLIENT
DFTNG. CHK.	JG	1" = 50'	6-27-84	MASTHEAD - SEC. 12
DRAWING TITLE				
SITE DEVELOPMENT PLAN - SOUTH HALF				

DWG. TYPE	FILE NUMBER	SHEET
		2
JOB NUMBER		OF 22
84100-00012		



NOTE: CUTS SHOWN ARE APPROXIMATE FROM EXISTING GRADE TO INVERT OF PROPOSED PIPE

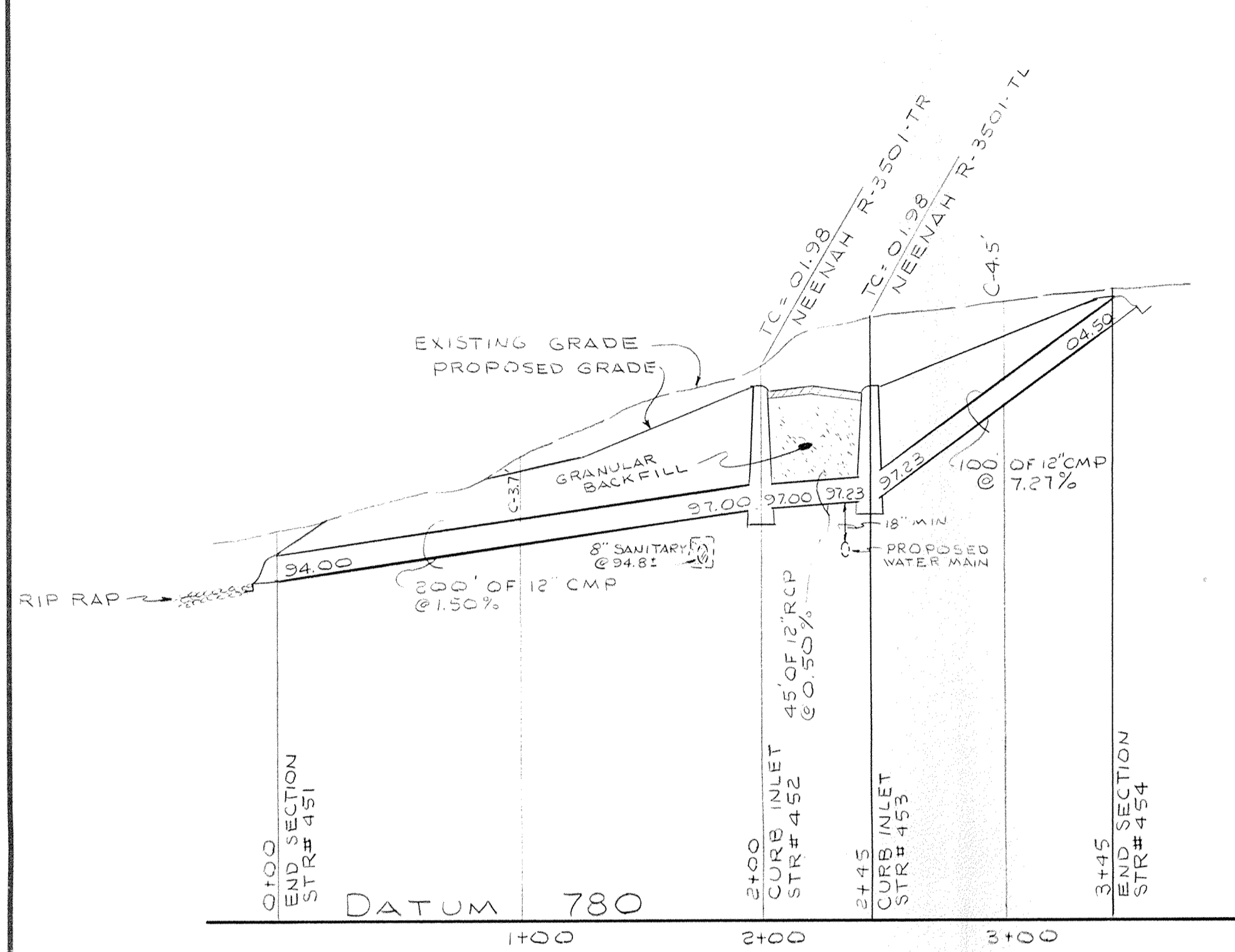

PROFILE ONE

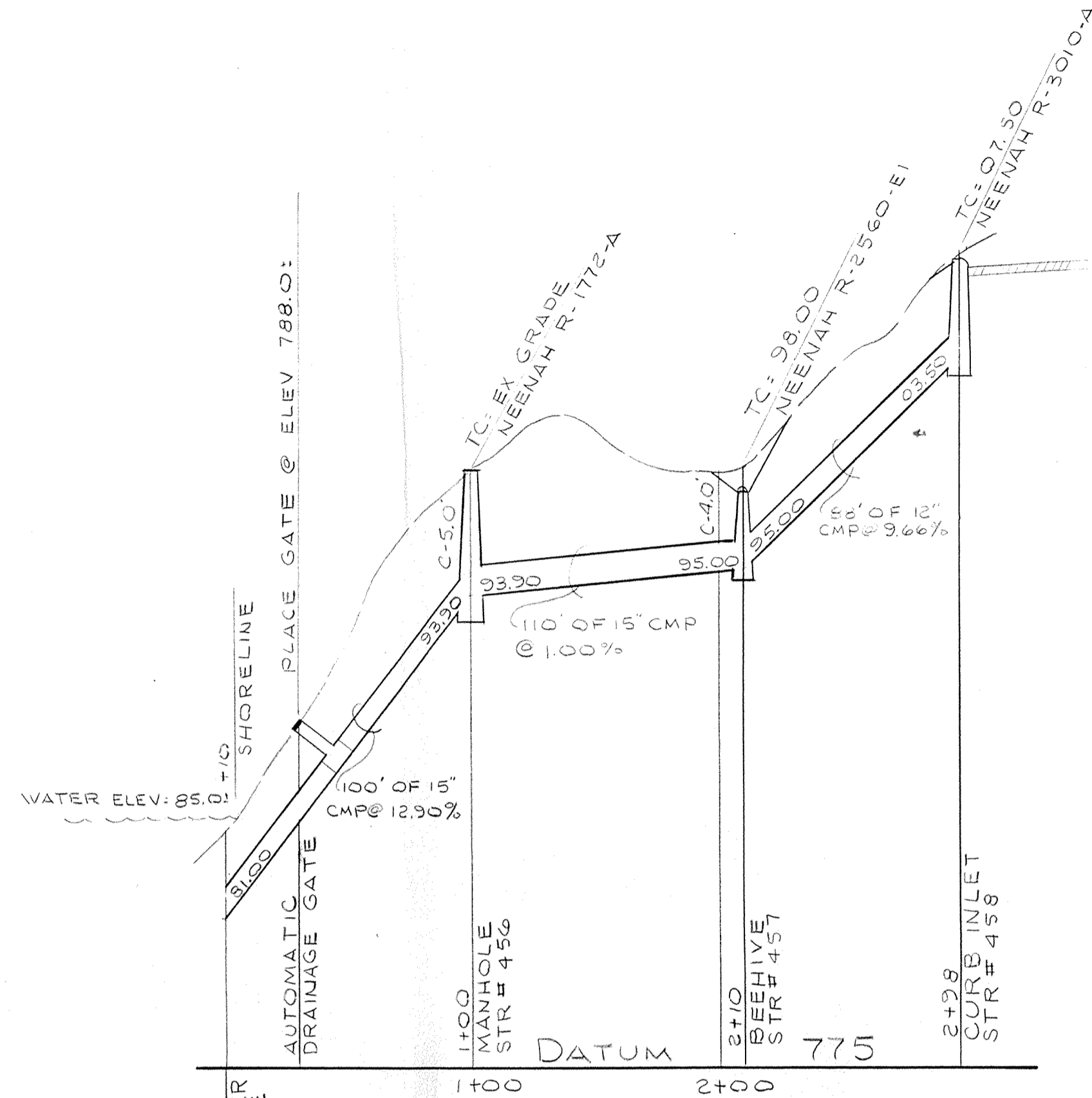

PROFILE TWO

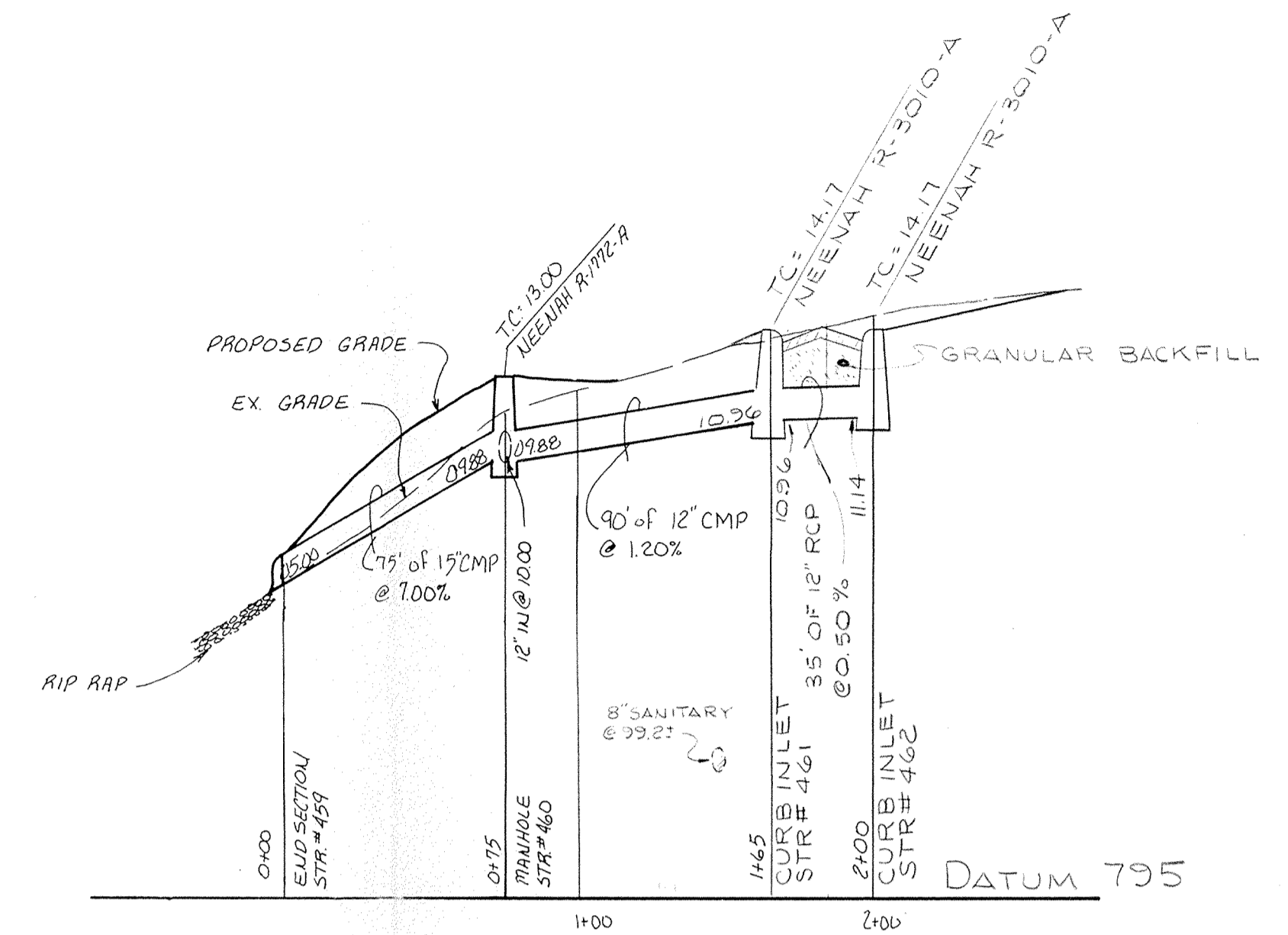

PROFILE THREE

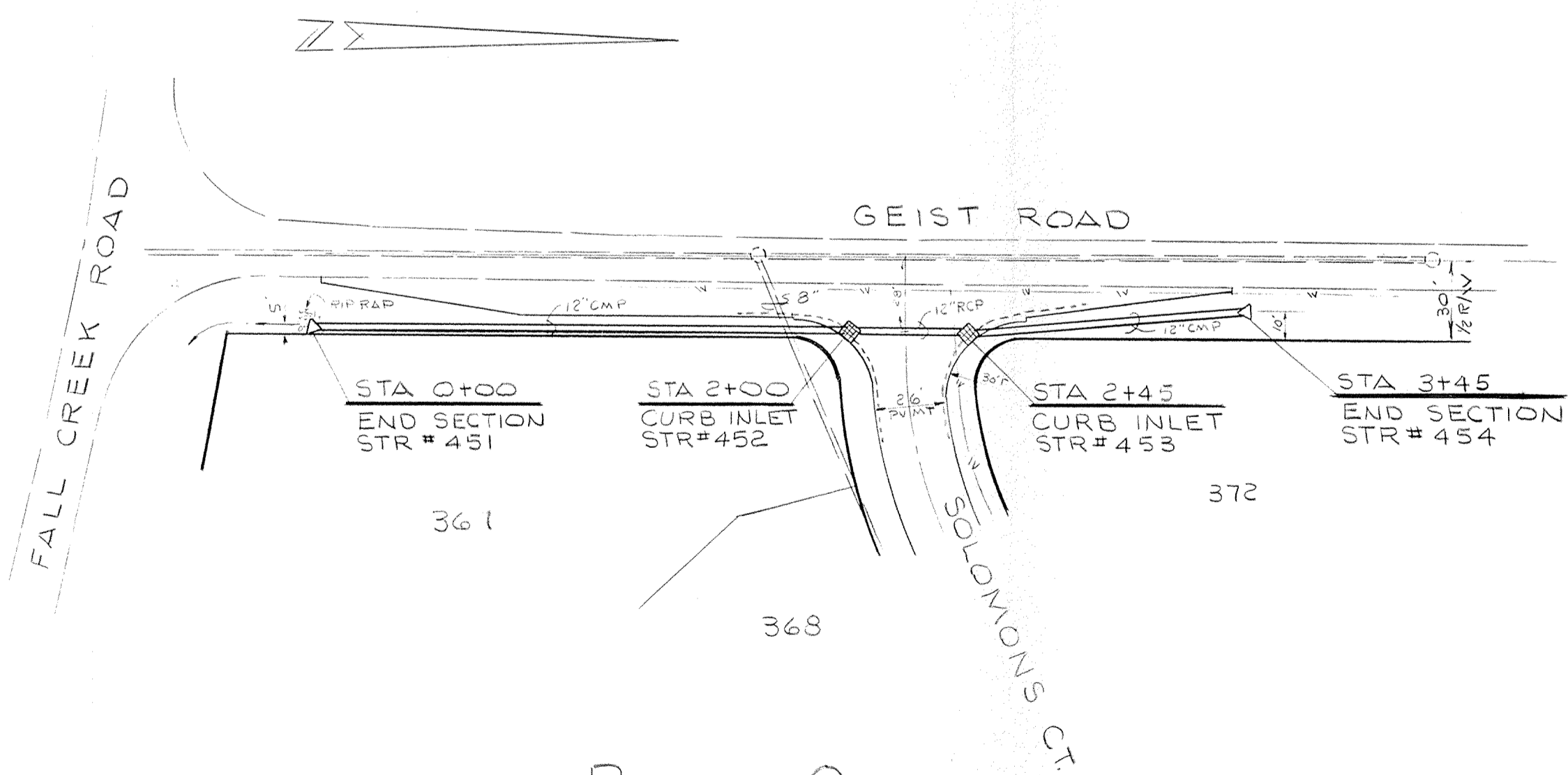

PLAN ONE

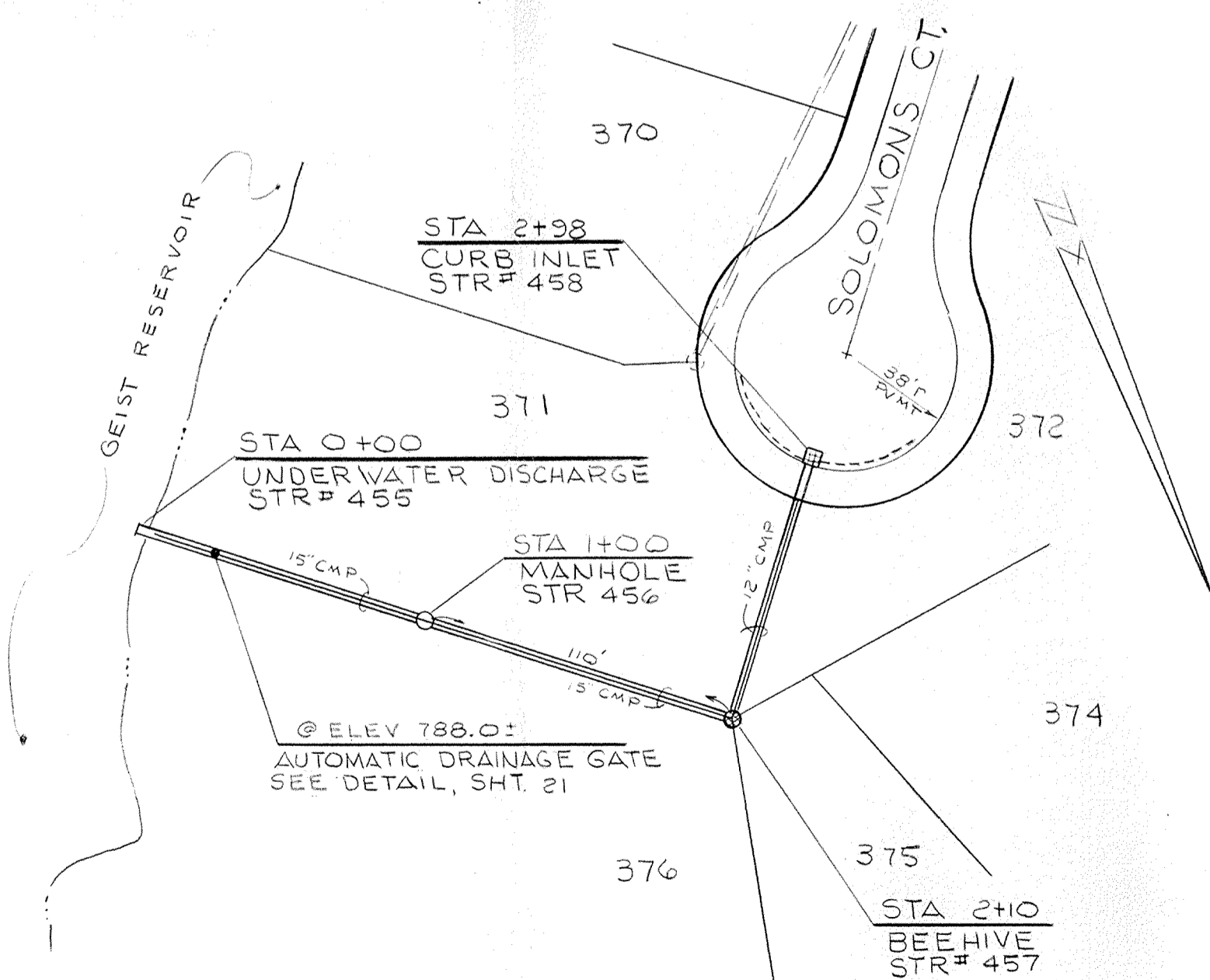

PLAN TWO

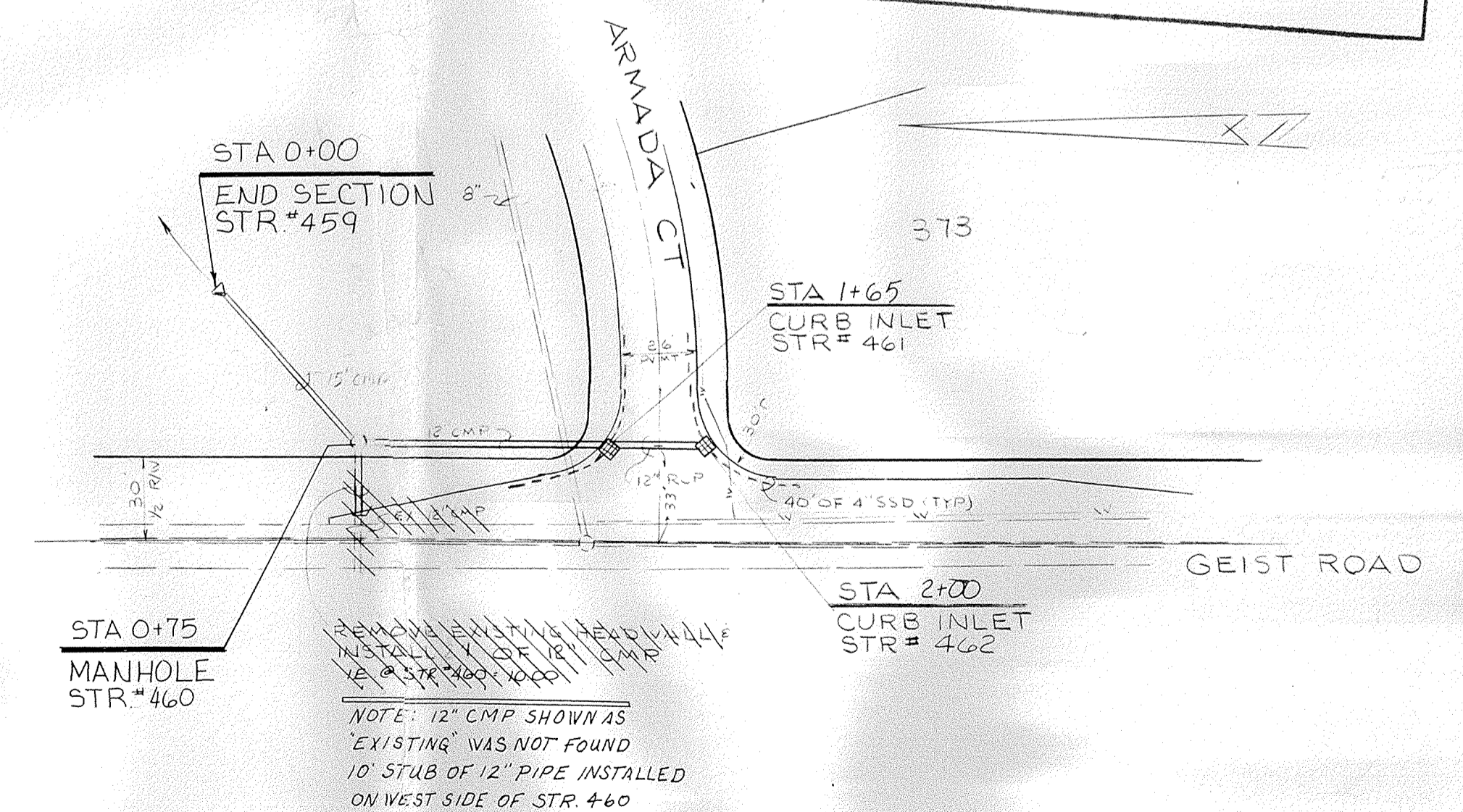

PLAN THREE

 This information was gathered for input into the Hamilton County Geographical Information System. This document is considered an official record of the GIS.  
 Entry Date: 1-23-04  
 Entered by: JDH

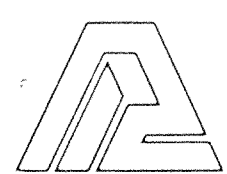
CERTIFIED BY	REVISIONS	 <b>PAUL I. CRIFE, INC.</b> 7172 GRAHAM ROAD INDIANAPOLIS, INDIANA 46250 317-842-6777	TECH. CHK.	DRAWN BY	SCALE	DATE	CLIENT	DWG. TYPE	FILE NUMBER	SHEET
			DFTNG. CHK.	DRAWING TITLE	HORIZ: 1" = 50'	6-27-84	MASTHEAD - SEC 12			18
DATE								JOB NUMBER		OF
								841100-00012		22



NOTE: CUTS SHOWN ARE APPROXIMATE FROM EXISTING GRADE TO INVERT OF PROPOSED PIPE

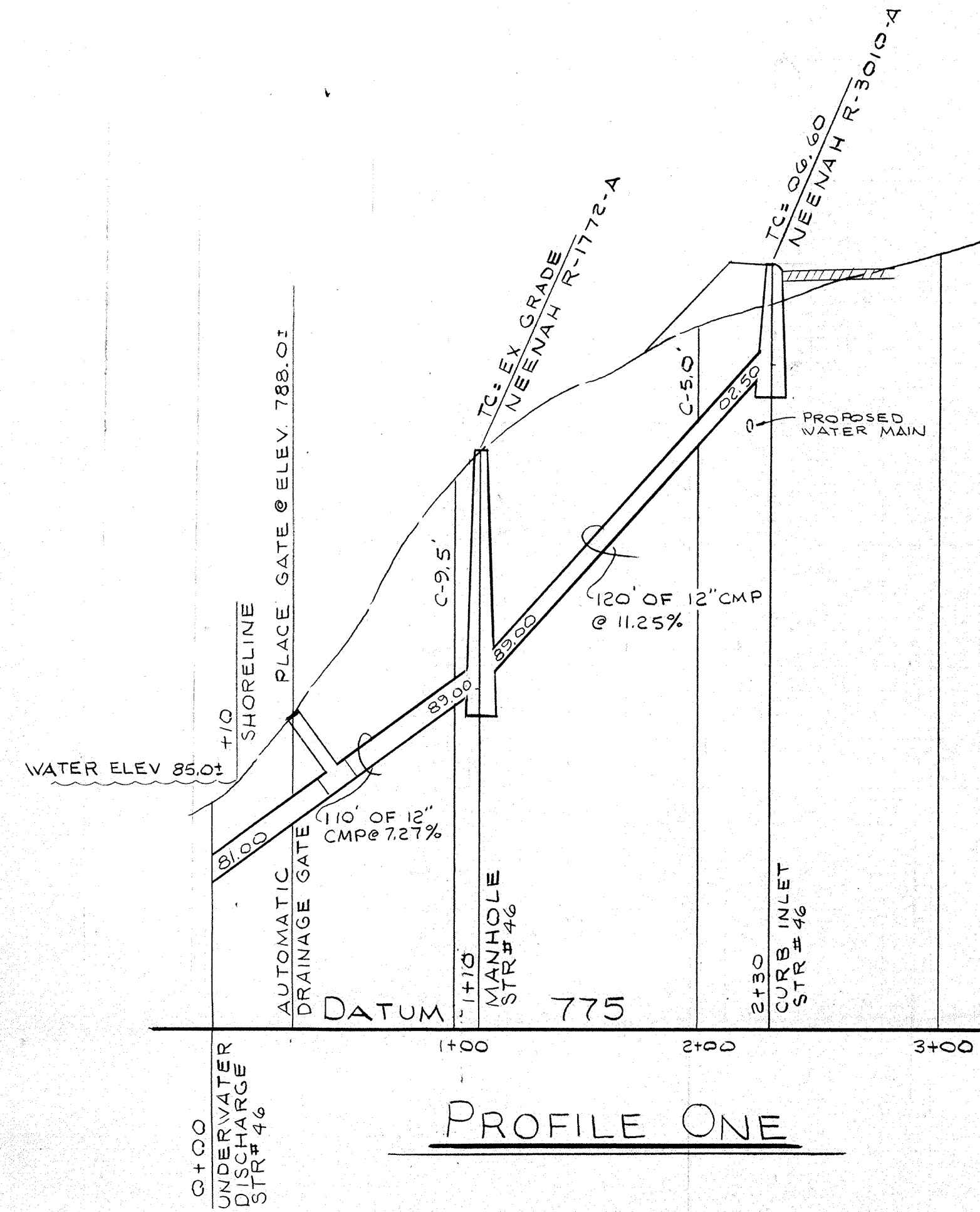

PROFILE ONE

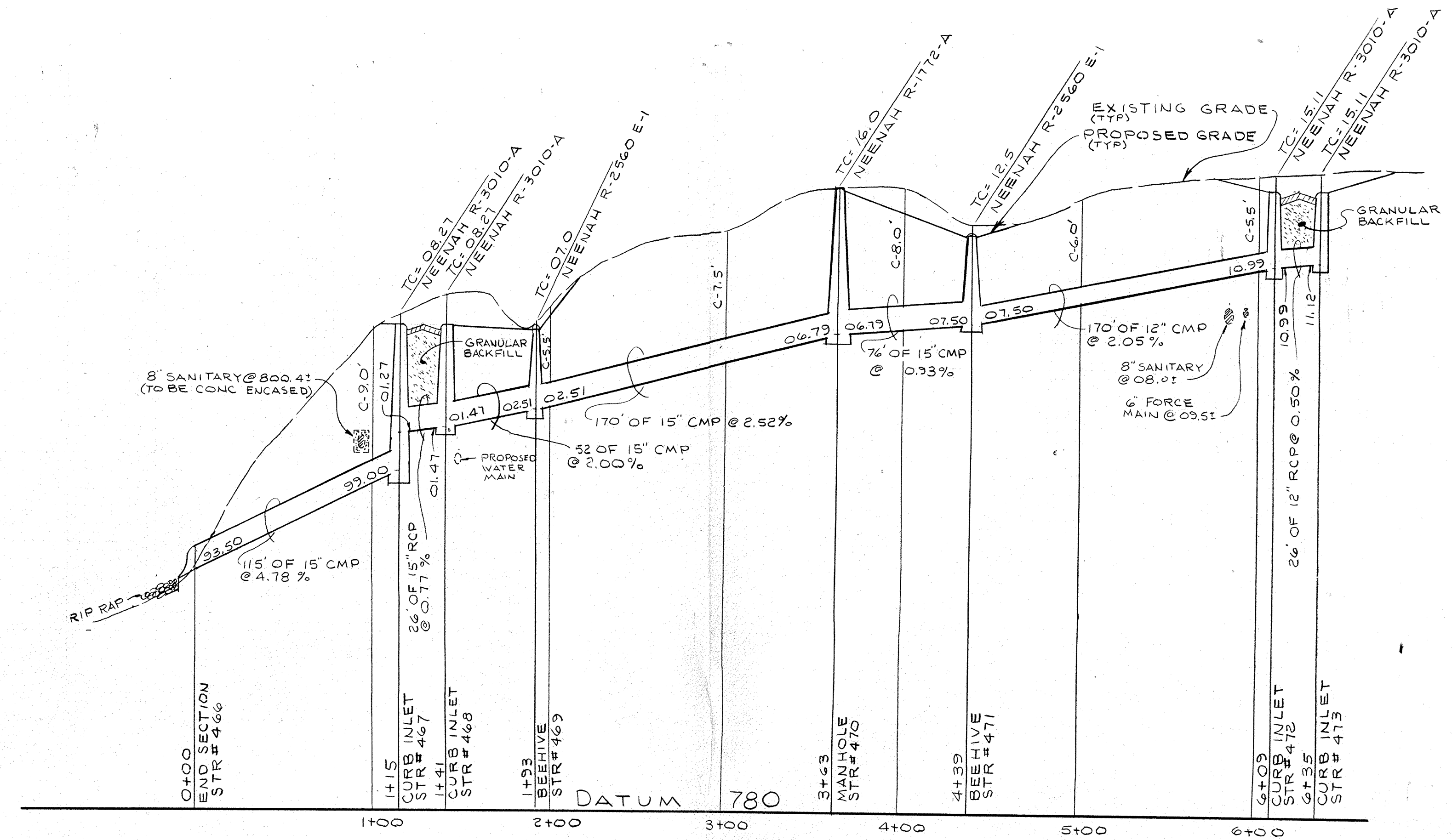

PROFILE TWO

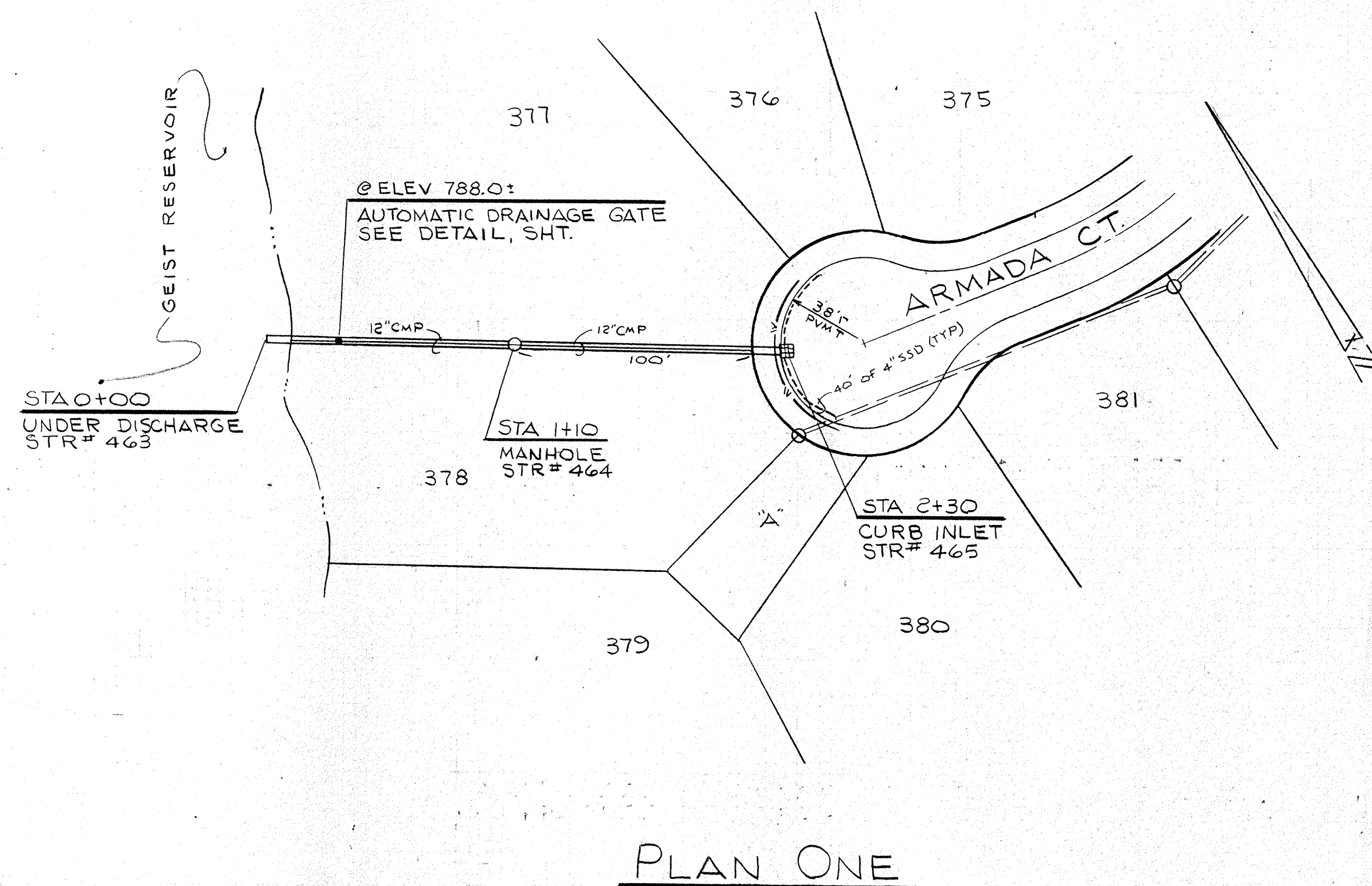

PLAN ONE

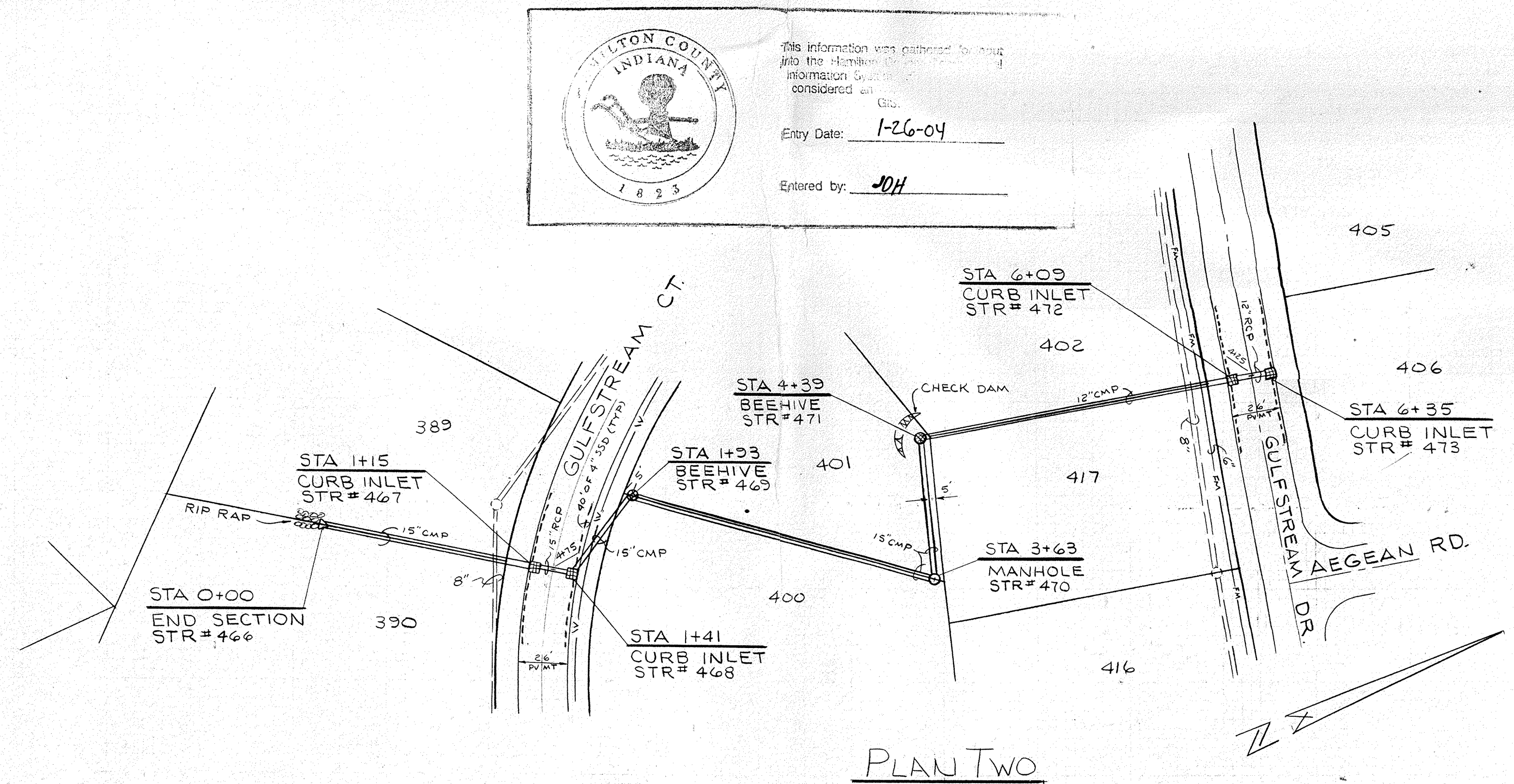

PLAN TWO

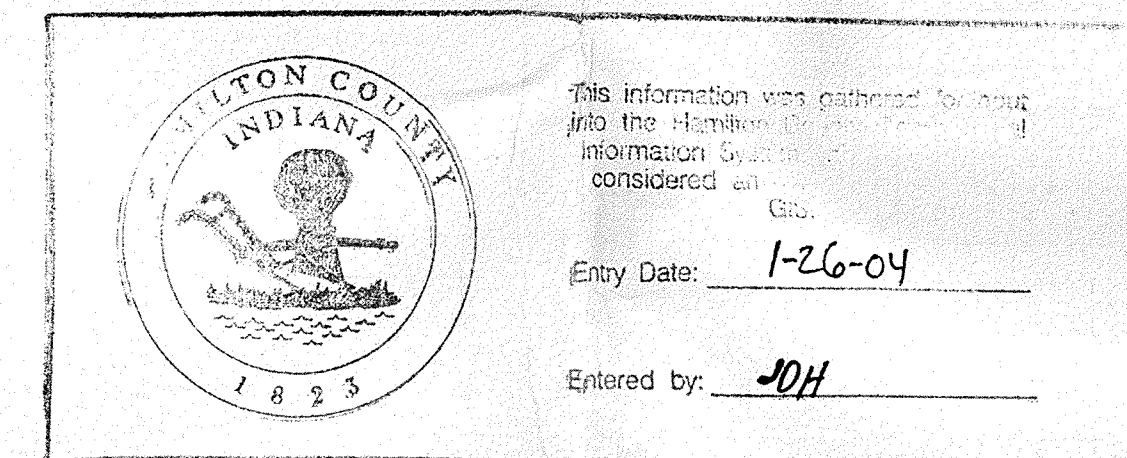

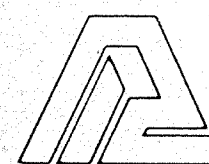
CERTIFIED BY	REVISIONS	 <b>PAUL I. CRIFE, INC.</b> • CIVIL ENGINEERING 7172 GRAHAM ROAD • LAND SURVEYING INDIANAPOLIS, INDIANA 46250 • ARCHITECTURE (317) 842-6777 • AND PLANNING	TECH. CHK.	DRAWN BY	SCALE	DATE	CLIENT	DWG. TYPE	FILE NUMBER	SHEET
	10-31-84 REV PIPE LENGTH & SLOPE BET. 468 & 469		JG	1" = 50'	6-27-84	Masthead - SEC 12		19		
DATE			DFTNG. CHK.	DRAWING TITLE		STORM SEWERS - PLAN & PROFILE		JOB NUMBER	84100100012	OF 22

NOTE: CUTS SHOWN ARE APPROXIMATE FROM EXISTING GRADE TO INVERT OF PROPOSED PIPE

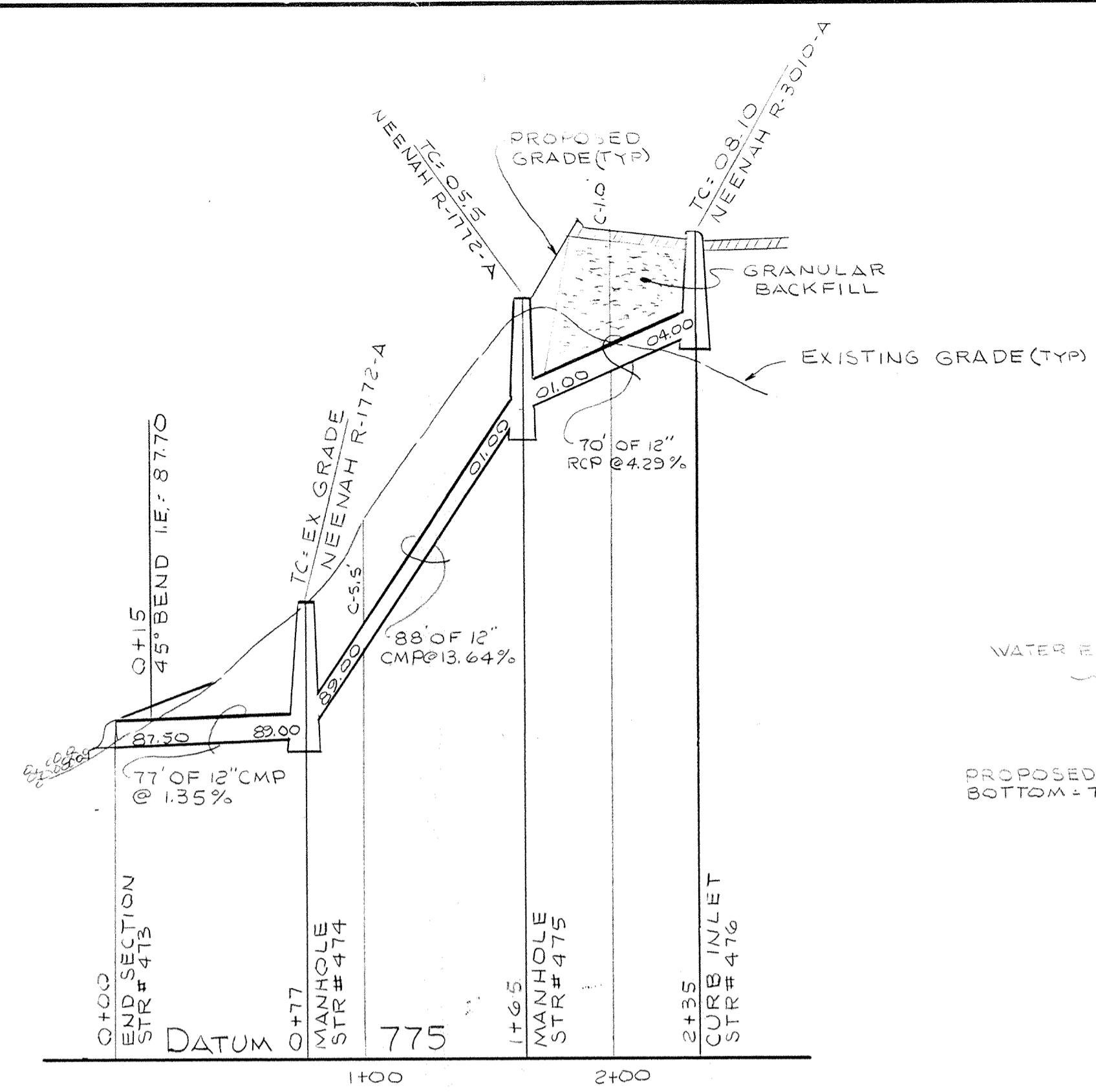

PROFILE ONE

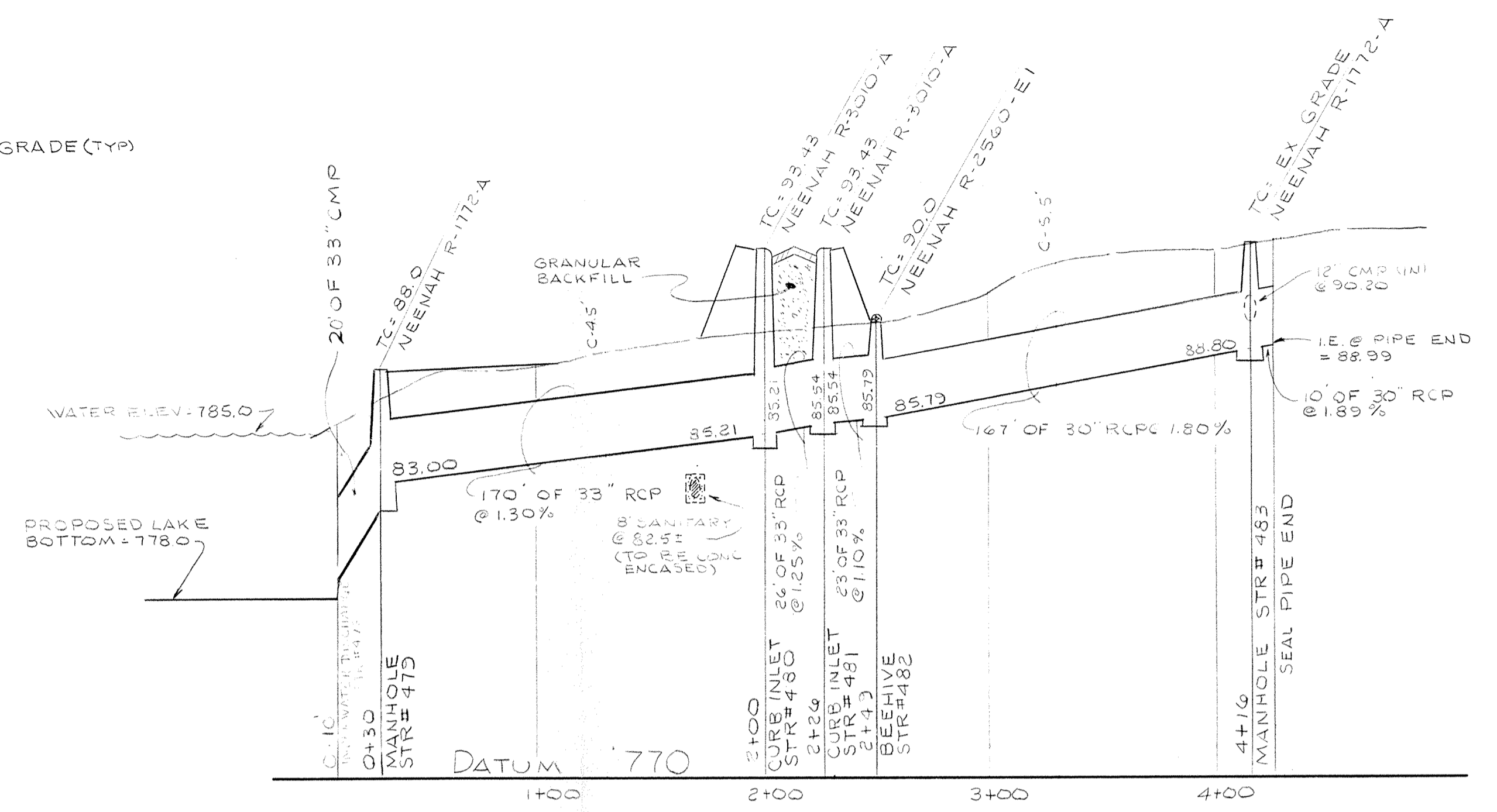

PROFILE TWO

This information was gathered for more info. If you have any questions, please contact the engineer. This information is considered an official record of the City.

Entry Date: 1-26-84

Entered by: JPH

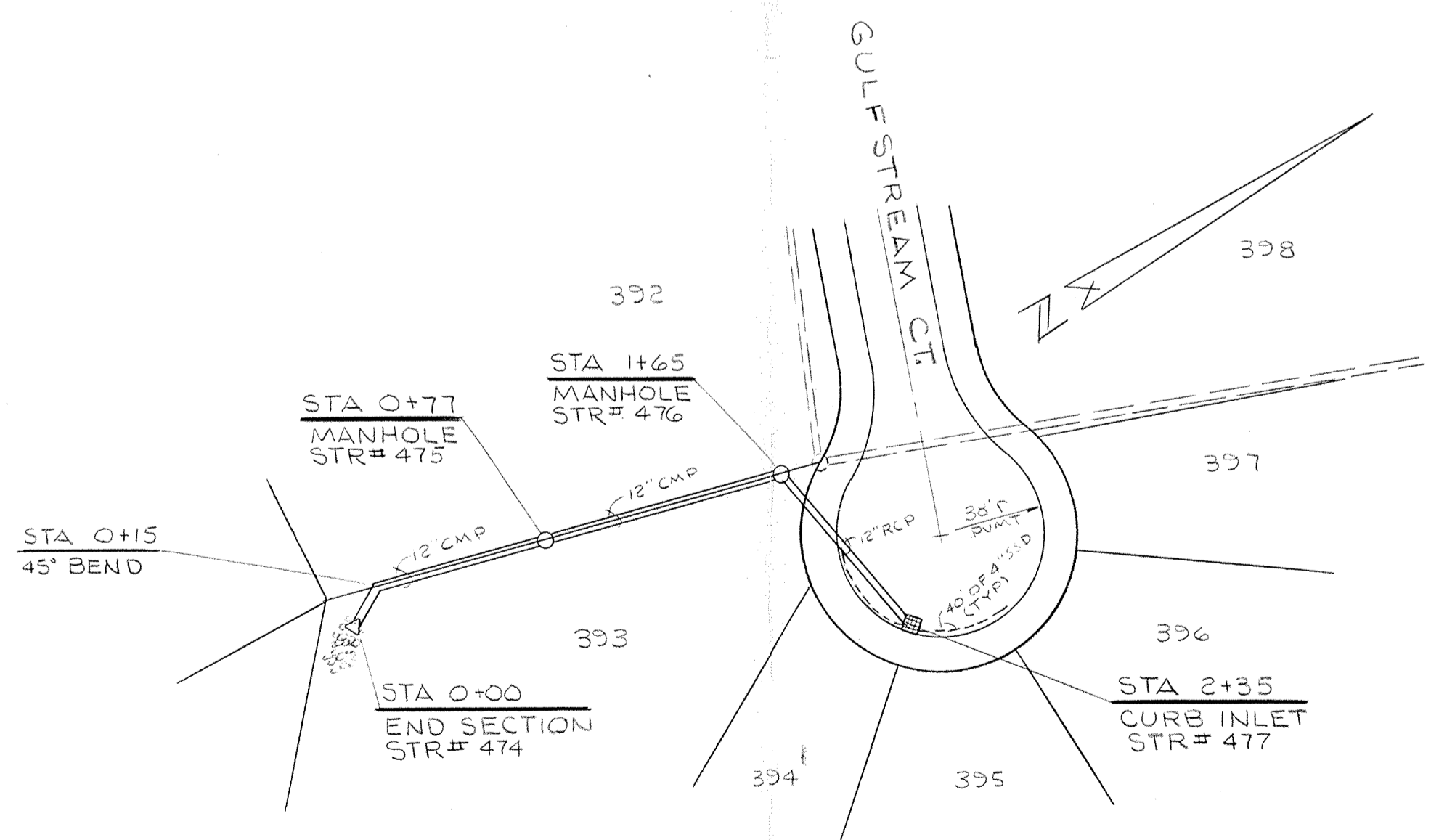

PLAN ONE

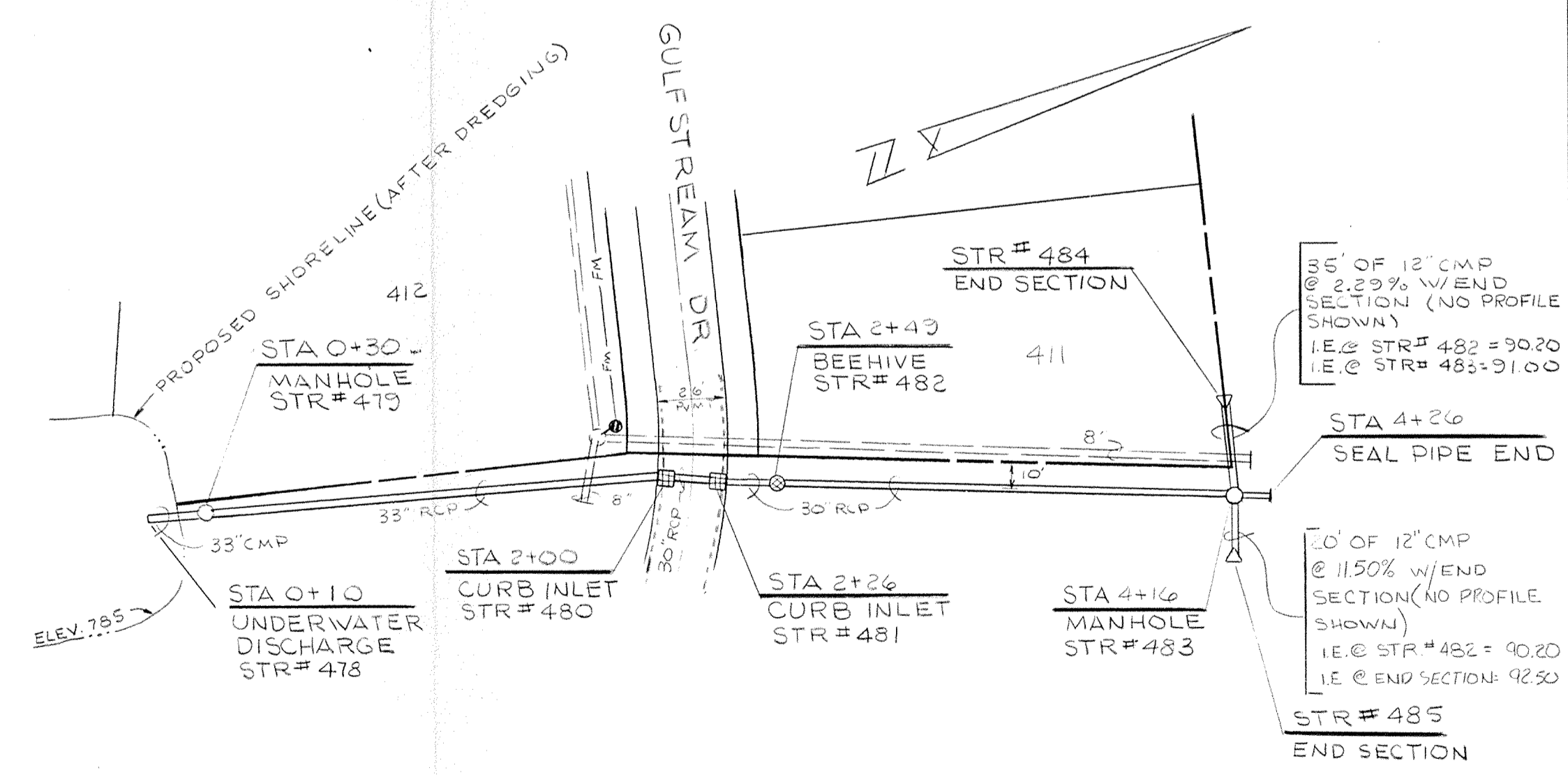

PLAN TWO

CERTIFIED BY	REVISIONS	<b>PAUL I. CRIFE, INC.</b> • CIVIL ENGINEERING 7172 GRAHAM ROAD • LAND SURVEYING INDIANAPOLIS, INDIANA 46250 • ARCHITECTURE 317-842-6777 • LAND PLANNING	TECH. CHK.	DRAWN BY	SCALE	DATE	CLIENT	DWG. TYPE	FILE NUMBER	SHEET
	10-12-84 REV PLAN & PROFILE TWO		JG	HORZ: 1"=50'	6-27-84	Masthead - SEC 12			20	
DATE			DFTNG. CHK.	DRAWING TITLE	STORM SEWERS - PLAN & PROFILE			JOB NUMBER	841100-000112	OF 22



**DIMENSIONS OF GALVANIZED STEEL END SECTIONS FOR ROUND PIPE**

PIPE DIA IN INCHES	GAGE	DIMENSIONS IN INCHES		
		A ± 1	B (max)	H ± 1
12	16	6	6	6
15	16	7	8	6
18	16	8	10	6
24	16	9	12	6
30	14	12	16	8
36	14	14	19	9
42	12	16	22	11
48	12	18	27	12
54	12	18	30	12
60	12	18	33	12
66	12	18	36	12
72	12	18	39	12
78	12	18	42	12
84	12	18	45	12

PIPE DIA IN INCHES	DIMENSIONS IN INCHES		APPROX SLOPE	BODY
	L 1/2	W 2		
12	21	24	2 1/2	1 pc.
15	26	30	2 1/2	1 pc.
18	31	36	2 1/2	1 pc.
21	36	42	2 1/2	1 pc.
24	41	48	2 1/2	1 pc.
30	51	60	2 1/2	1 pc.
36	60	72	2 1/2	2 pc.
42	69	84	2 1/2	2 pc.
48	78	90	2 1/4	2 pc.
54	84	102	2	2 pc.
60	87	114	1 3/4	3 pc.
66	87	120	1 1/2	3 pc.
72	87	126	1 1/3	3 pc.
78	87	132	1 1/4	3 pc.
84	87	138	1 1/6	3 pc.

STD. PIPE SIZE & CONN. USAGE GALVANIZED STEEL PIPE	
TYPE CONN. #1	ROUND 12" THRU 24"
#2	30" THRU 36"
#3	42" THRU 84"
PIPE - ARCH	
#2	18"x11" THRU 58"x36"
#3	65"x40" THRU 85"x54"

CASTING	A	B	C	D
R-1772-A	25"	DIAMETER	21"	4'-0"
R-2560-E1	27"	DIAMETER	24"	4'-0"
R-3010-A	24"	25"	27"	4'-0"
R-3501	25"	27"	30"	4'-4"
			36"	5'-0"
			42"	5'-4"
			48"	6'-0"
			54"	6'-6"

**STANDARD CONNECTIONS:** TYPE #1 SHALL BE CONNECTOR LUG WITH THREADED ROD. TYPE #2 SHALL BE THREADED ROD WITH ROD HOLDERS. TYPE #3 SHALL BE RIVETED OR BOLTED CONNECTION.

**NOTE:** STANDARD DIMENSIONS FOR GALVANIZED STEEL END SECTIONS FOR PIPE-ARCH MAY BE FOUND ON MISC. STANDARDS SHEET E<sub>2</sub>, DATED JULY, 1972, OF THE INDIANA STATE HIGHWAY STANDARD SPECIFICATIONS.

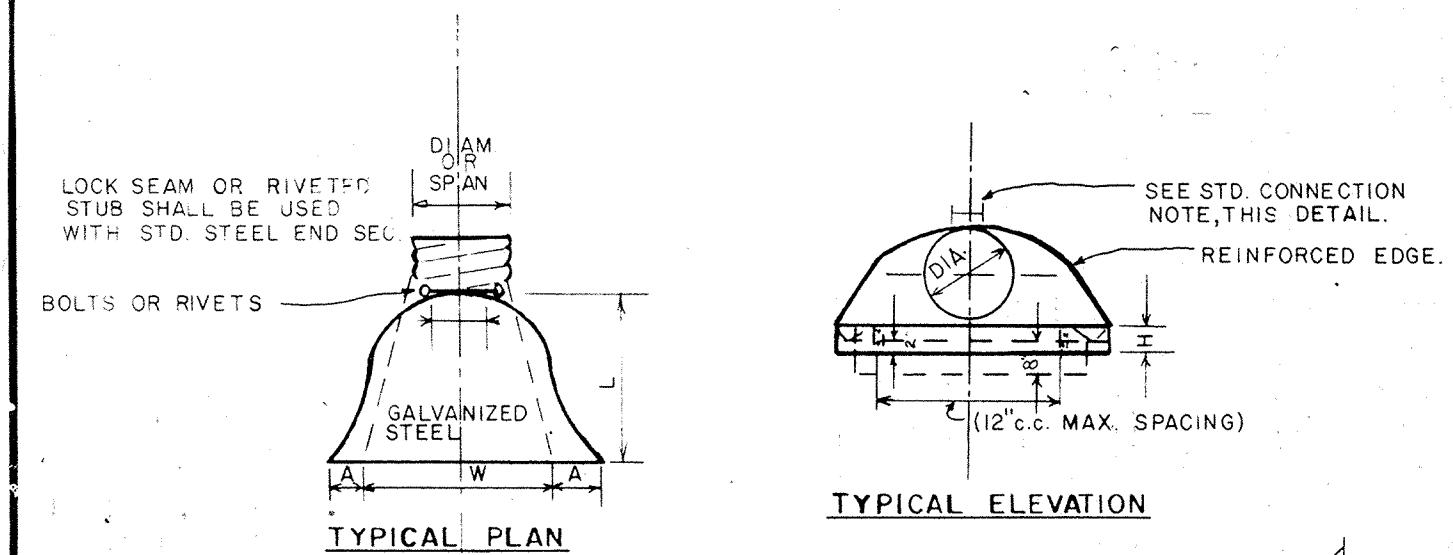

**TYPICAL CROSS SECTION**  
PIPE OR PIPE-ARCH WITH #3 CONN. TO LOCK SEAM OR RIVETED STUB.

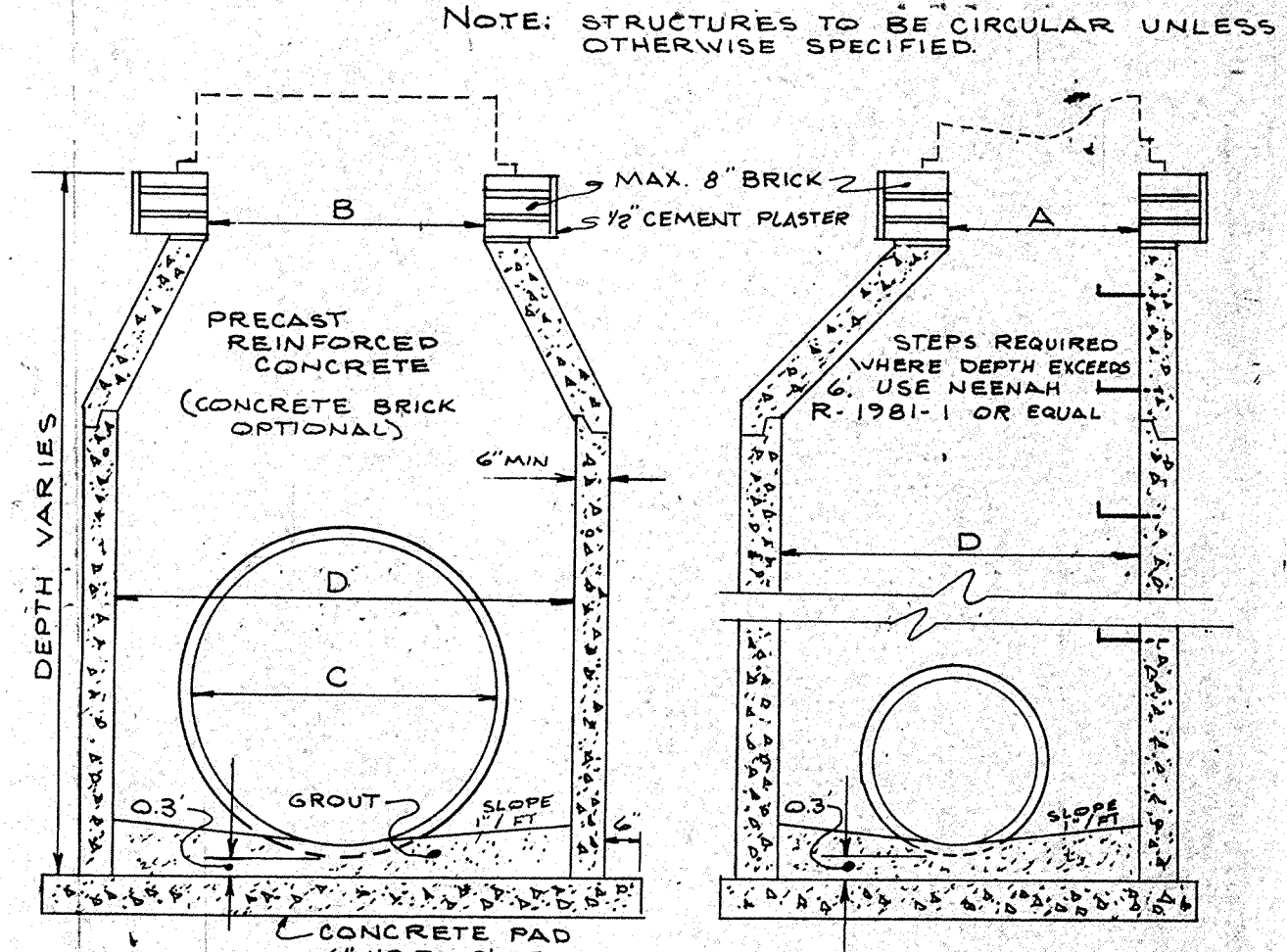

**STORM MANHOLE & DEEP INLET**  
N.T.S.

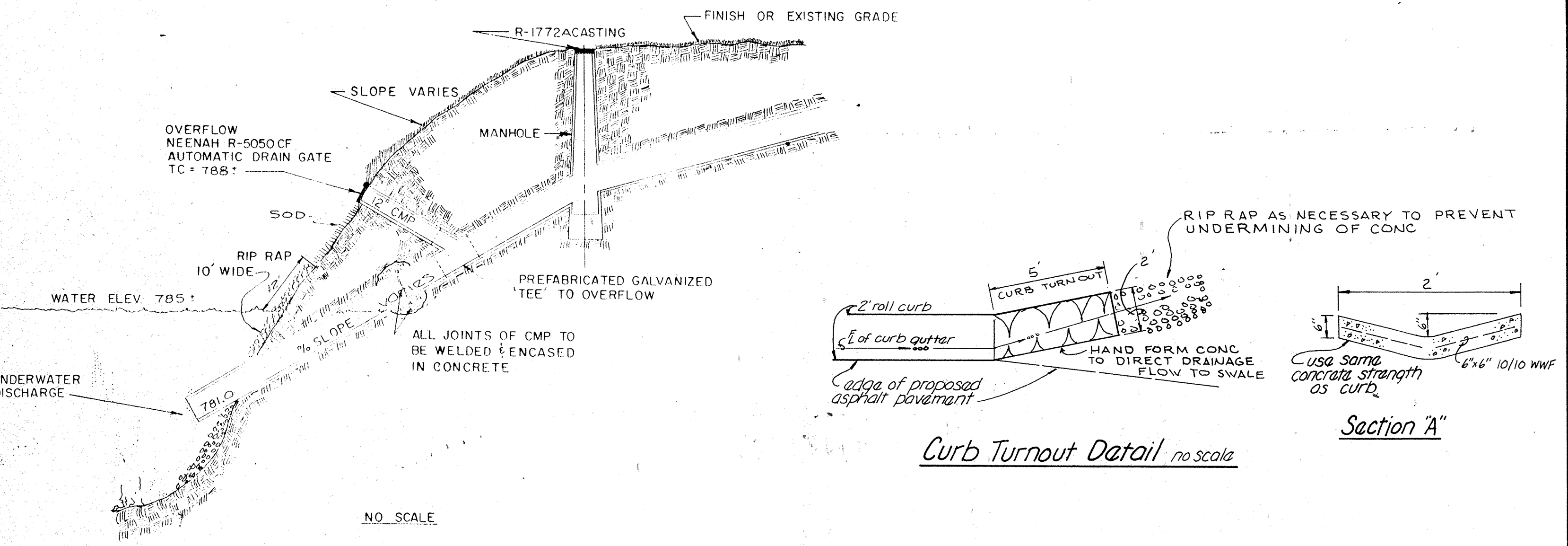

**TYPICAL UNDERWATER DISCHARGE DETAIL**  
NO SCALE

**STANDARD STEEL END SECTION DETAIL**  
SCALE: NONE

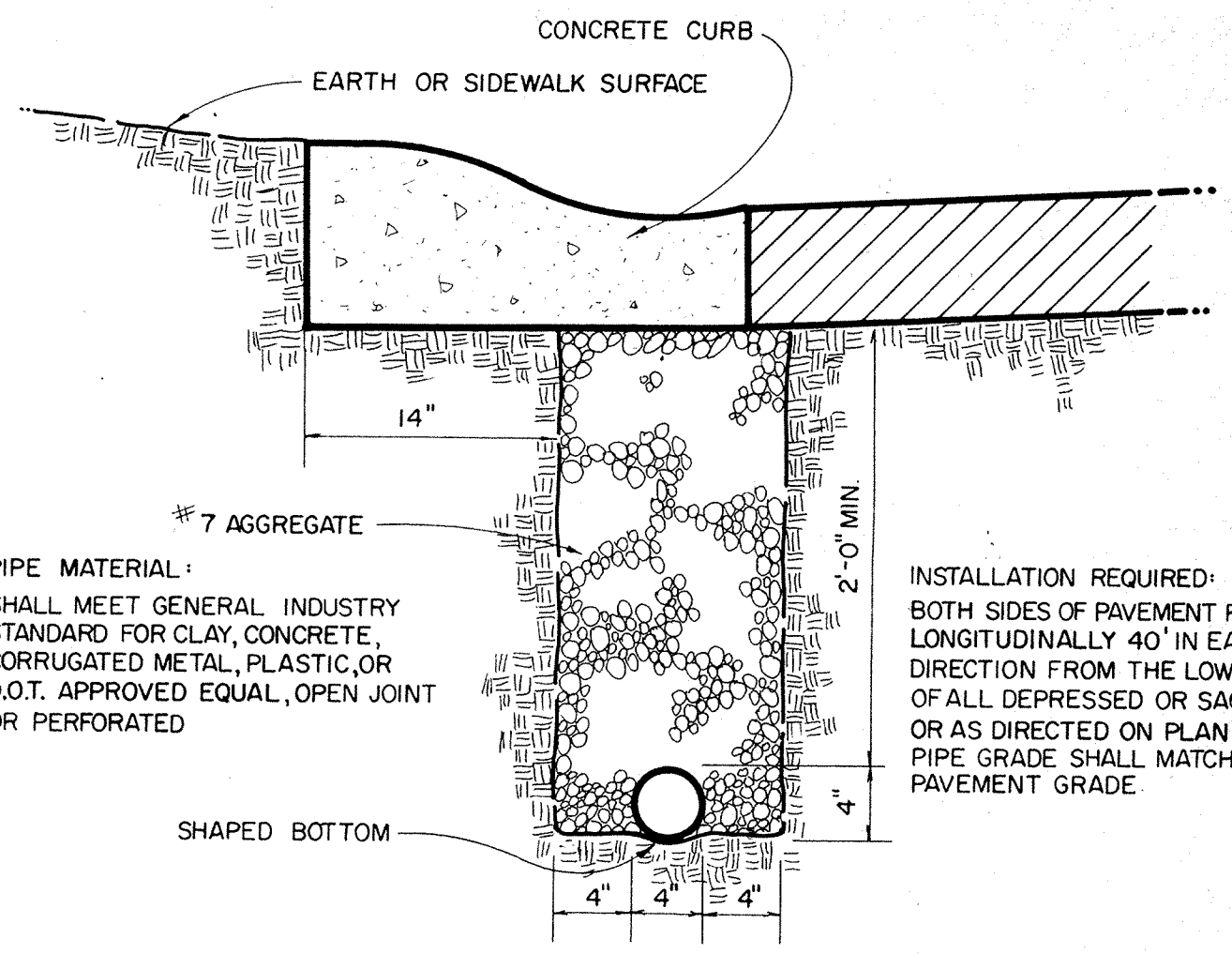

**PIPE UNDERDRAIN**  
TYPICAL INSTALLATIONS NO SCALE

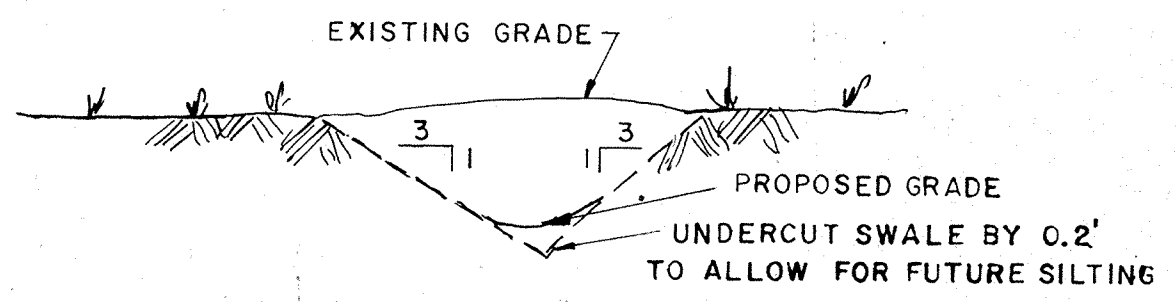

**TYPICAL SWALE DETAIL**  
SCALE: NONE

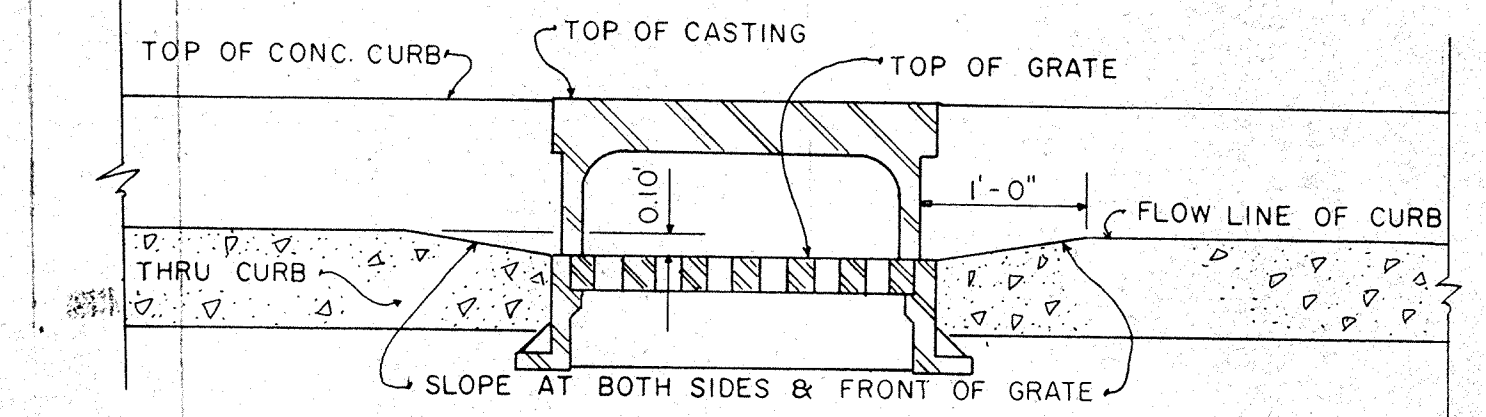

**CURB INLET SETTING DETAIL**  
SCALE: NONE

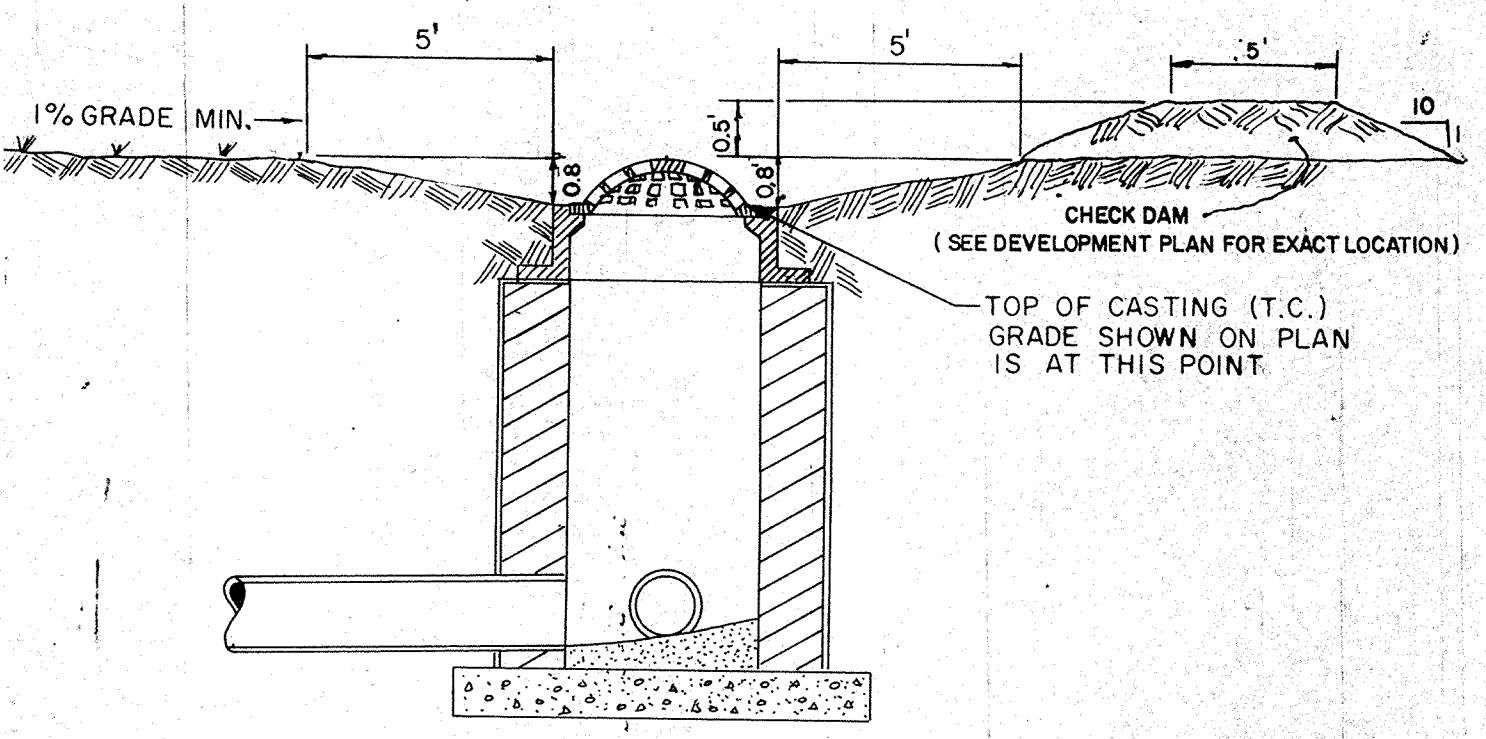

**BEEHIVE CASTING SETTING DETAIL**  
NOT TO SCALE

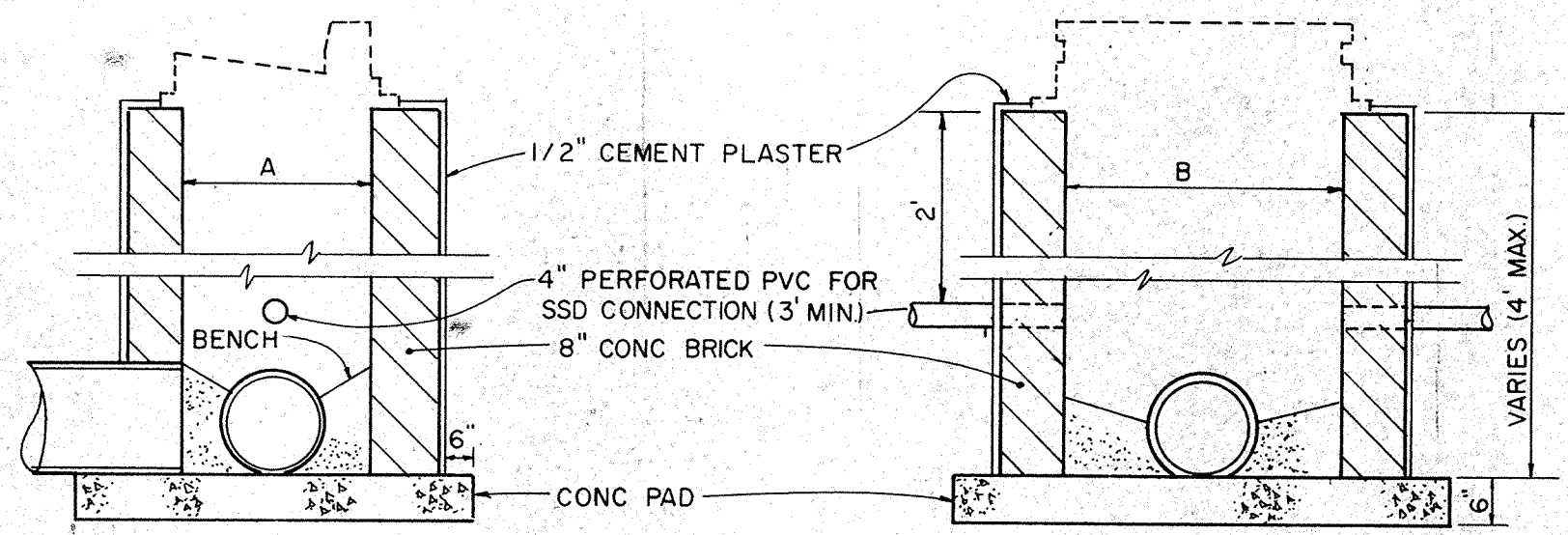

**SHALLOW CURB INLET**  
SCALE: NONE

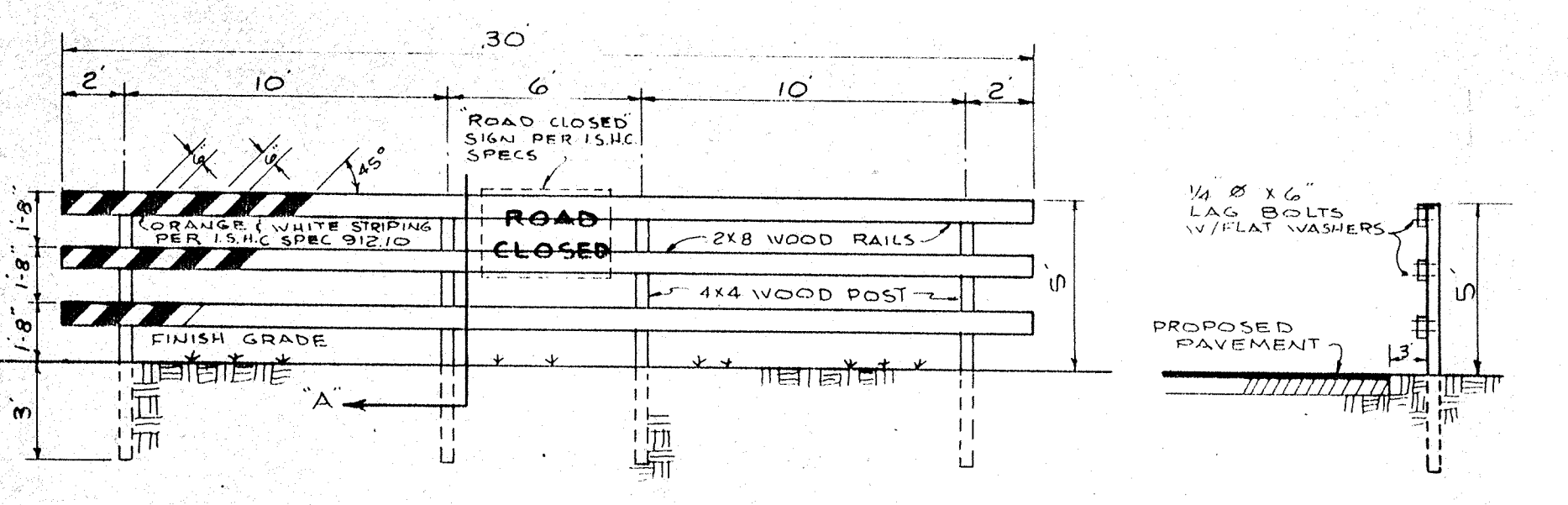

**BARRICADE DETAIL**  
N.T.S.

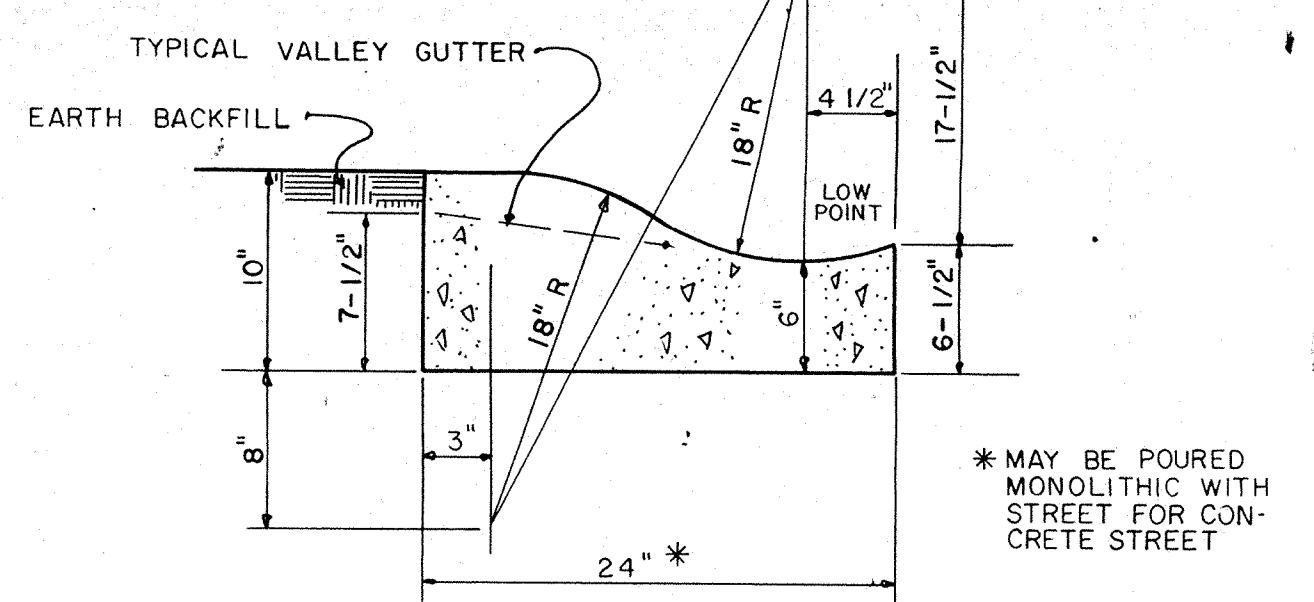

**TYPICAL CURB DETAIL WITH VALLEY GUTTER**  
SCALE: NONE

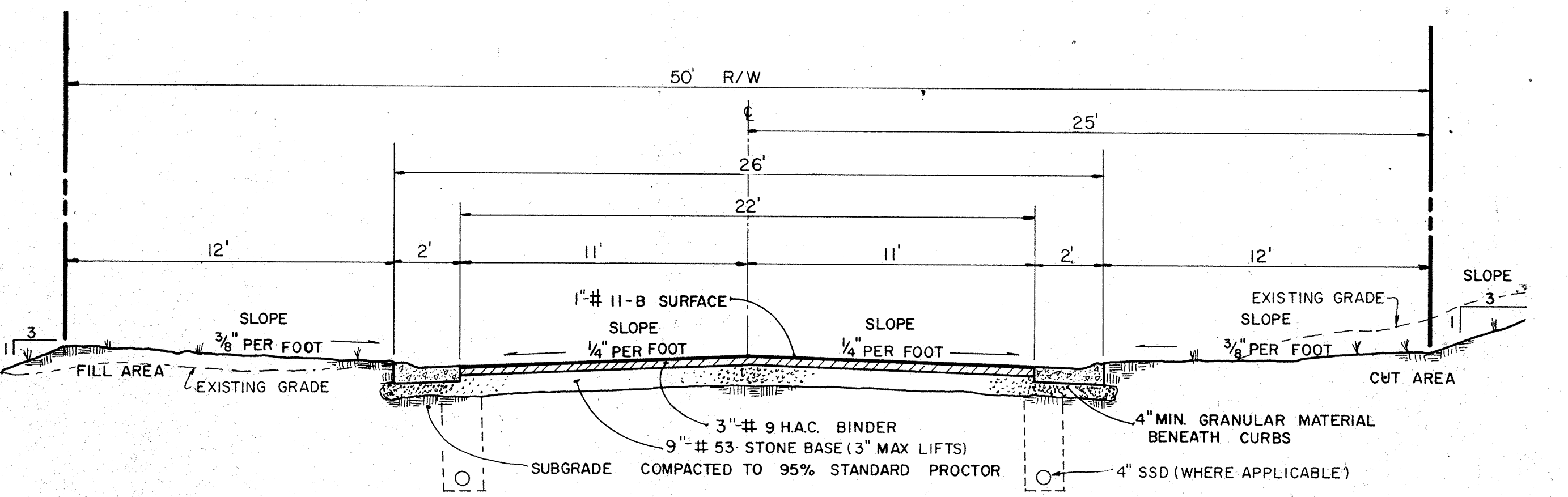

NOTE: ALL METHODS AND MATERIALS OF STREET CONSTRUCTION SHALL BE IN ACCORDANCE WITH I.S.H.A. SPECS. (1976) SEC. 403, 902.01, 903.01 AND 903.02 WITHOUT WRITTEN CHANGE FROM ENGINEER

**TYPICAL STREET CROSS-SECTION (W/ CURBS)**  
SCALE: NONE

CERTIFIED BY	REVISIONS	PAUL I. CRIFE, INC. 7172 GRAHAM ROAD INDIANAPOLIS, INDIANA 46250 317-842-6777	TECH. CHK. DRAWN BY SCALE DATE CLIENT	J.G. noted 6-27-84 Masthead Sac. 12	DWG. TYPE	FILE NUMBER	SHEET
					841100-00012	21	
DATE			DFTNG. CHK. DRAWING TITLE	Standard Details & Specifications	JOB NUMBER	841100-00012	OF 22



